



FAI Sporting Code

*Fédération
Aéronautique
Internationale*

Section 4 – Aeromodelling

Volume F3 Radio Control Aerobatics

2013 Edition

Effective 1st January 2013

No change to 2012 Edition

F3A - R/C AEROBATIC POWER MODEL AIRCRAFT
F3M - LARGE R/C AEROBATIC POWER MODEL AIRCRAFT
F3P - INDOOR R/C AEROBATIC POWER MODEL AIRCRAFT
F3S - JET R/C AEROBATIC POWER MODEL AIRCRAFT (PROVISIONAL)
ANNEX 5A - F3A DESCRIPTION OF MANOEUVRES
ANNEX 5B - F3 R/C AEROBATIC POWER MODEL AIRCRAFT
MANOEUVRE EXECUTION GUIDE
ANNEX 5G - F3A UNKNOWN MANOEUVRE SCHEDULES
ANNEX 5L - F3M DESCRIPTION OF MANOEUVRES
ANNEX 5M - F3P DESCRIPTION OF MANOEUVRES
ANNEX 5X - F3S DESCRIPTION OF MANOEUVRES
ANNEX 5N - F3A WORLD CUP RULES

*Maison du Sport International
Avenue de Rhodanie 54
CH-1007 Lausanne
Switzerland
Tel: +41(0)21/345.10.70
Fax: +41(0)21/345.10.77
Email: sec@fai.org
Web: www.fai.org*

II

FEDERATION AERONAUTIQUE INTERNATIONALE

Maison du Sport International, Avenue de Rhodanie 54, CH-1007 Lausanne, Switzerland

Copyright 2013

All rights reserved. Copyright in this document is owned by the Fédération Aéronautique Internationale (FAI). Any person acting on behalf of the FAI or one of its Members is hereby authorised to copy, print, and distribute this document, subject to the following conditions:

- 1. The document may be used for information only and may not be exploited for commercial purposes.**
- 2. Any copy of this document or portion thereof must include this copyright notice.**

Note that any product, process or technology described in the document may be the subject of other Intellectual Property rights reserved by the Fédération Aéronautique Internationale or other entities and is not licensed hereunder.

RIGHTS TO FAI INTERNATIONAL SPORTING EVENTS

All international sporting events organised wholly or partly under the rules of the Fédération Aéronautique Internationale (FAI) Sporting Code¹, are termed *FAI International Sporting Events*². Under the FAI Statutes³, FAI owns and controls all rights relating to FAI International Sporting Events. FAI Members⁴ shall, within their national territories⁵, enforce FAI ownership of FAI International Sporting Events and require them to be registered in the FAI Sporting Calendar⁶.

Permission and authority to exploit any rights to any commercial activity at such events, including but not limited to advertising at or for such events, use of the event name or logo for merchandising purposes and use of any sound and/or image, whether recorded electronically or otherwise or transmitted in real time, must be sought by way of prior agreement with FAI. This includes specifically all rights to the use of any material, electronic or other, that forms part of any method or system for judging, scoring, performance evaluation or information utilised in any FAI International Sporting Event⁷.

Each FAI Air Sport Commission⁸ is authorised to negotiate prior agreements on behalf of FAI with FAI Members or other entities as appropriate, of the transfer of all or parts of the rights to any FAI International Sporting Event (except World Air Games events⁹) which is organised wholly or partly under the Sporting Code section¹⁰ for which that Commission is responsible¹¹. Any such transfer of rights shall be by "Organiser Agreement"¹² as specified in the current FAI Bylaws Chapter 1, para 1.2 "Rules for Transfer of Rights to FAI International Sporting Events".

Any person or legal entity which accepts the responsibility for organising an FAI Sporting Event, whether or not by written agreement, in doing so also accepts the proprietary rights of FAI as stated above. Where no formal transfer of rights has been established, FAI retains all rights to the event. Regardless of any agreement or transfer of rights, FAI shall have, free of charge for its own archival and/or promotional use, full access to any sound and/or visual images of any FAI Sporting Event, and always reserves itself the right to have any and all parts of any event recorded, filmed and/or photographed for such use, without charge.

1 FAI Statutes, Chapter 1, para. 1.6

2 FAI Sporting Code, General Section, Chapter 3, para 3.1.3

3 FAI Statutes, Chapter 1, para 1.8.1

4 FAI Statutes, Chapter 2, para 2.1.1; 2.4.2 ; 2.5.2 ; 2.7.2

5 FAI Bylaws, Chapter 1, para 1.2.1

6 FAI Statutes, Chapter 2, para 2.4.2.2.5

7 FAI Bylaws, Chapter 1, para 1.2.3

8 FAI Statutes, Chapter 5, para 5.1.1; 5.5 ; 5.6

9 FAI Sporting Code, General Section, Chapter 3, para 3.1.7

10 FAI Sporting Code, General Section, Chapter 1, paras 1.2. and 1.4

11 FAI Statutes, Chapter 5, para 5.6.3

12 FAI Bylaws, Chapter 1, para 1.2.2

PAGE DELIBERATELY LEFT BLANK

VOLUME F3 AEROBATICS

SECTION 4C – MODEL AIRCRAFT – F3 – RADIO CONTROL AEROBATICS

Part Five – Technical Regulations for Radio Controlled Contests

- 5.1. Class F3A -R/C Aerobatic Power Model Aircraft
- 5.10 Class F3M -Large R/C Aerobatic Power Model Aircraft
- 5.9 Class F3P -Indoor R/C Aerobatic Power Model Aircraft
- 5.12 Class F3S -R/C Jet Aerobatic Power Model Aircraft (Provisional)
- Annex 5A F3A -Description of Manoeuvres
- Annex 5B F3 -R/C Aerobatic Power Model Aircraft Manoeuvre Execution Guide
- Annex 5G - F3A -Unknown Manoeuvre Schedules
- Annex 5 L - F3M -Description of Manoeuvres
- Annex 5M - F3P -Description of Manoeuvres
- Annex 5X - F3S -Description of Manoeuvres
- Annex 5N - F3A -World Cup Rules



THIS 2013 EDITION INCLUDES THE FOLLOWING AMENDMENTS MADE TO THE 2012 CODE

These amendments are marked by a double line in the right margin of this edition

Paragraph	Plenary meeting approving change	Brief description of change	Change incorporated by
There were no changes at the 2012 Plenary Meeting			
Front page, Page 5	n/a	Corrected class F3S as “provisional”.	Technical Secretary
5.1.13		A14.10, P-15.06, F15.03, F-15.07 corrected title to match K factor list and description test. Schedule A-12 deleted in K factor list, manoeuvre descriptions and Aresti diagram.	
5B.8.3		Corrected English in the third paragraph.	
5.1.1	2011	Variable thrust direction not allowed	Michael Ramel S-C Chairman
5.1.2		Propulsion shut-off/idle at R/C failure	
5.1.2		Battery charging for sound re-test	
5.1.2		Exception of R/C open loop definition	
5.1.2		Additional restrictions for control functions	
5.1.5		Clarification of propulsion failure	
5.1.8		Clarification of marking procedure	
5.1.8		Re-definition of manoeuvring zone	
5.1.8		Re-definition reasons for forced landing	
5.1.9		Precision of procedures	
5.1.10		Precision of procedures	
5.1.11		Reduction of number of models processed for teams	
5.1.11		Precision of procedures	
5.1.11		Procedure for voltage check	
5.1.11		Procedure for connecting/disconnecting electric power	
5.1.11		Flight time split in 2min starting time, 8min flying time	
5.1.12		Precision of procedures	
5.1.13		Introduction of Advanced Schedules A-12, A-14	
5.1.13		Implementation of Preliminary Schedules P-13, P-15	
5.1.13		Implementation of Semi-final/Final schedules F-13, F15	
Annex 5A		Manoeuvre description A-12, A-14	
Annex 5A		Manoeuvre description P-13, P-15	
Annex 5A		Manoeuvre description F-13, F-15	
Annex 5B		Introduction of Manoeuvre Execution Guide	
Annex 5G		Computer composition of Unknown Schedules possible	
Annex 5G		Increased challenges in Unknown Schedules	
Annex 5G		Additional Unknown Manoeuvres	
5.10.3	Noise level limit raised		
5.10.14	Implementation of Known Schedule 2012-2013		
Annex 5L	Description of Known Schedule 2012-2013		
5.9.1, 2, 9, 11	n/a	Rationalisation of commonality with F3A in part.	
5.9.5, 6, 7, 8,	n/a	Rationalisation of commonality with F3A entirely	
5.9.1	2011	Variable thrust direction not allowed, except for F3P-AFM	
5.9.8		Redefinition of manoeuvring area, precision of procedures	
5.9.9 – 5.9.12		Precision of procedures	
5.9.13		Preliminary Schedule F3P-AP-13	

cont/...2011 Amendments

Paragraph	Plenary meeting approving change	Brief description of change	Change incorporated by
AP-13.06	n/a	Added missing words "¼ roll down"	Michael Ramel S-C Chairman
5.9.13	2011	Final Schedule F3P-AF-13	
AF-13.06	n/a	Added missing word "Upright".	
5.9.14		Consequential change: deleted as now part of the fully amended Annex 5B.	
Annex 5M	2011	Manoeuvre descriptions of F3P-AP-13, F3P-AF-13	
Annex 5N		Five (5) judges per panel, TBL mandatory for World Cup Competition	
Annex 5 N	n/a	Corrected the F3 Aerobatic Sub-committee name	Jo Halman Technical Secretary
5.12	2011	New provisional class F3S - Jets	
Throughout	n/a	"Security line" changed to "Safety line".	
		Added section headers for clarity	

Four-Year Rolling Amendments for Reference			
Paragraph	Plenary meeting approving change	Brief description of change	Change incorporated by
Rule Freeze	2010	New text to clarify rule change cycles. Consequential change for ABR reference from A.12 to A.13.	Jo Halman Technical Secretary
5.10.9	n/a	Split the paragraph into a) to i) for clarity	
No changes were made at the 2010 Plenary Meeting			
Front page, page 5	n/a	Consequential changes regarding 5.9 & 5.10 as official classes	Jo Halman Technical Secretary
Page 9		Updated the rule freeze paragraph	
Page 11		Corrected title	
5.1.3	2009	Specified requirements for disabled competitors	Michael Ramel S-C Chairman
5.1.5		Simplified definition of an attempt	
5.1.11		Precision of time keeping	
5.1.11		Correction of reference	
5.1.12		Precision of execution of manoeuvres	
5.1.13		Correction of manoeuvre description	
Annex 5A	n/a	Deleted obsolete manoeuvre schedules and diagrams P.09 & F.09	Michael Ramel S-C Chairman
Annex 5A: P-11.01		Rationale correction: deleted "up"	
P-11.07,		Rationale correction: "complete" to "perform" add "with"	
P-11.08		Rationale correction: delete "in either direction"	
P-11.13		Rationale correction: delete "to complete"; insert "through" and amend text in Judging Notes 2nd bullet point	
P-11.16		Rationale correction: delete "to complete"; insert "through"	
P-11.17		Corrected text for clarification; changed "Spin" to "Turn" in Judging Notes 3rd bullet point	

Four-year Rolling Amendments for Reference.../cont

Four-Year Rolling Amendments for Reference			
Paragraph	Plenary meeting approving change	Brief description of change	Change incorporated by
F-11.02		Rationale correction: delete "to complete"; insert "through"	
F-11.05		Corrected to correspond to the Judges Guide	
F-11.09		Rationale correction: delete "to complete"; insert "through"	
F-11.16		Added Judging notes as corresponding manoeuvre in F3A	
Annex 5 G	n/a	Amended title to follow protocol	
5.10	2009	F3M from Provisional (Annex 5L) to Official class 5.10. Rules renumbered and relocated; (late correction).	
5.10.10	n/a	Corrected normalisation formula	Jo Halman Technical Secretary
5.10.13		Corrected for English	
5.10.14		Deleted unnecessary date & corrected cross-reference	
5.10.15		Amended title to follow rationale	
Annex 5L		Amended title for clarity & protocol; added note at end	
5.9	2009	F3P from Provisional (Annex 5M) to Official class 5.9	
5.9.9	n/a	Deleted erroneous "semi-finals"	Jo Halman Technical Secretary
5.9.10 c)		Inserted omitted text	
5.9.10 e)		Deleted erroneous "unknown"	
5.9.10 f)		Corrected cross reference	
5.9.11		Corrected cross reference	
5.9.13	n/a	AP-07 corrected to "half roll down"	Michael Ramel S-C Chairman
5.9.13		AP-08 corrected to "centre manoeuvre"	
5.9.14		Amended title to follow protocol	
5.9.8, 5.9.12 c), e), g), j), l, 5.9.13, Annex 5M		All occurrences and references to "AeroMusicals" are now "Aerobatics Freestyle to Music and "AM" are now "AFM"	
Annex 5M		Amended titles to follow protocol	
Annex 5M, AP10		AP-10 amended Judging Notes to specify "distance from"; added notes regarding location of manoeuvre descriptions.	Michael Ramel S-C Chairman
Annex 5N.3b	2009	Redefinition of World Cup scores	
5.1.11	n/a	Corrected reference.	Technical Secretary
5.1.13		P-11.14 deleted erroneous "inverted text"	
Annex 5L.1.10		Deleted erroneous "S" from the formula	

RULE FREEZE FOR THIS VOLUME

With reference to paragraph A.13 of Volume ABR:

In all classes, the two-year rule for no changes to model aircraft/space model specifications, manoeuvre schedules and competition rules will be strictly enforced. For Championship classes, changes may be proposed in the year of the World Championship of each category.

For official classes without Championship status, the two-year cycle begins in the year that the Plenary Meeting approved the official status of the class. For official classes, changes may be proposed in the second year of the two-year cycle.

- a) changes for F3A, F3M, and F3P can next be agreed at the Plenary meeting 2013 for application from January 2014;
- b) provisional classes are not subject to this restriction.

The only exceptions allowed to the two-year rule freeze are genuine and urgent safety matters, indispensable rule clarifications and noise rulings.

PAGE DELIBERATELY LEFT BLANK

VOLUME F3 AEROBATICS**PART FIVE – TECHNICAL REGULATIONS FOR RADIO CONTROLLED CONTESTS****5.1. CLASS F3A – AEROBATIC POWER MODEL AIRCRAFT****5.1.1. Definition of a Radio Controlled Aerobatic Power Model Aircraft**

A model aircraft, but not a helicopter, which is aerodynamically manoeuvred in attitude, direction, and altitude by a pilot on the ground using radio control. Variable thrust direction of the propulsion device(s) is not allowed.

5.1.2. General Characteristics of Radio Controlled Aerobatic Power Models:

Maximum overall span2000mm

Maximum overall length2000mm

Maximum total weight, with batteries5000g

A tolerance of 1% will be allowed for possible inconsistencies in measurement instruments for size, weight, and voltage unless otherwise stated.

Propulsion device limitations: Any suitable propulsion device may be utilised. Propulsion devices that are not permitted are those requiring solid expendable propellants, gaseous fuels (at room temperature and atmospheric pressure), or liquefied gaseous fuels. Electric powered model aircraft are limited to a maximum of 42.56 volts for the propulsion circuit, measured off load, and prior to flight while the competitor is in the ready box.

The propulsion device(s) must automatically shut-off or fully idle at the moment a R/C signal failure occurs.

Paragraph B.3.1.a) of Section 4B (Builder of Model aircraft) is not applicable to class F3A.

The maximum sound/noise level of the model aircraft and its propulsion device, shall be 94 dB(A) measured at 3m from the centre line of the model aircraft with the model aircraft placed on the ground over concrete, macadam, grass, or bare earth at the flight line.

The tolerance of the sound/noise level measurement is the specified tolerance of the manufacturer of the measuring instrument.

With the propulsion device running at full power, the measurement will be taken 90 degrees on the right-hand side, with the nose of the model aircraft pointing into the wind. The Class 1 SLM (Sound Level Meter) microphone shall be placed on a stand 30cm above the ground in line with the propulsion device. Other than the helper restraining the model aircraft, and the sound steward, no persons or sound/noise reflecting or sound absorbing objects shall be nearer than 3m to the model aircraft or the microphone. The sound/noise measurement shall be made immediately prior to each flight. The sound test area must be located in a position that does not create a safety hazard to officials and other competitors.

The flight time will be interrupted while the sound/noise test at the flying site is being made. The competitor shall not be delayed more than 30 seconds for this sound test.

In the event of a model aircraft failing the sound/noise test, no indication of the result or the reading shall be given to the competitor, or his team, or the judges, and both the transmitter and the model aircraft shall be impounded by the flight line official immediately following the flight. No modification or adjustment to the model aircraft shall be permitted (other than refuelling or battery recharging). The competitor and his equipment shall remain under supervision of the flight line director while the propulsion battery is fully recharged. The model aircraft shall be re-tested within 90 minutes by a second noise steward using a second Sound Level Meter, and in the event that the model aircraft fails the re-test, the score for the preceding flight shall be zero. The score for the flight may be tabulated but not made public until the result of the re-test is communicated to the tabulators.

Radio equipment shall be of the open loop type (ie no electronic feedback from the model aircraft to the ground except for the stipulations in Volume ABR B.11.2). Auto-pilot control utilising inertia, gravity or any type of terrestrial reference is prohibited. Automatic control sequencing (pre-programming) or automatic control timing devices are prohibited.

Example: Permitted:

1. Control rate devices that are manually switched by the pilot.
2. Any type of button or lever, switch, or dial control that is initiated or activated and terminated by the competitor.
3. Manually operated switches or programmable options to couple and mix control functions.

Not permitted:

1. Snap roll buttons with automatic timing mode.
2. Pre-programming devices to automatically perform a series of commands.
3. Auto-pilots or gyros for automatic wing levelling or other stabilisation of the model aircraft.
4. Automatic flight path guidance.
5. Propeller pitch change with automatic timing mode.
6. Any type of voice recognition system.
7. Conditions, switches, throttle curves, or any other mechanical or electronic device that will prevent or limit sound level of the propulsion device during the sound/noise test.
8. Any type of learning function involving manoeuvre to manoeuvre or flight to flight analysis.

5.1.3. **Definition and Number of Helpers**

A helper may be a Team Manager, another competitor, or an officially registered supporter. Each competitor is permitted one helper (usually the caller) during the flight. Two helpers may be present and assist during the starting of the motor(s). One person, either a helper, or the team manager, or the caller, may place the model aircraft for take-off and retrieve the model aircraft following the landing. In exceptional circumstances, another helper may join the competitor and caller/helper during the flight, but only to hold a sun-shield as protection from direct sunlight. These protection devices must not interfere with the judges' vision of the manoeuvres. Physically disabled competitors requiring an additional helper and/or caller or other assistance, must request permission with full details, with their entry, from the organiser of a championship. This additional assistance must be provided by the competitor, must not give him an unfair advantage over other competitors, and must not unduly delay or interfere with the running of the competition. Except for communication between the caller and the competitor, no other performance-enhancing communication with helpers is permitted during the flight.

5.1.4. **Number of Flights**

Competitors have the right to the same number of preliminary, semi-final, or finals flights. Only completed rounds will be counted. Only when all competitors in the preliminary, semi-final, and final rounds, have had the opportunity to complete the same number of rounds, can the results of the rain-interrupted (or other delay) competition be determined.

5.1.5. **Definition of an Attempt**

There is an attempt when the competitor is given permission to start.

If the propulsion device fails after the take-off has begun, the attempt will be deemed complete.

5.1.6. **Number of Attempts**

Each competitor is entitled to one attempt for each official flight.

Note: An attempt can be repeated at the contest director's discretion only when any unforeseen reason beyond the control of the competitor, causes the model aircraft to fail to start (eg there is radio interference). Similarly, in a flight that is interrupted by any circumstance beyond the control of the competitor, the competitor is entitled to a reflight, with the entire schedule being flown and judged, but only the affected manoeuvre and the unscored manoeuvres that follow will be tabulated. This reflight should take place within 30 minutes of the first flight, in front of the same set of judges, or be the first flight after the judges' break, or, if it involves a protest, as soon as the FAI Jury has deliberated and communicated the outcome of the protest to the contest director. The result of the reflight will be final.

5.1.7. **Definition of an Official Flight**

There is an official flight when an attempt is made whatever the result.

5.1.8. Marking

Each judge has to assess each manoeuvre and any other relevant action of the competitor individually and independently from the other judges. The criteria for judging are contained in the Description of Manoeuvres (Annex 5M) and in the Manoeuvre Execution Guide (Annex 5B)

Each manoeuvre may be awarded marks, in whole numbers, between 10 and 0 by each of the judges during the flight. During tabulation, these marks are multiplied by a coefficient (K-Factor) which relates to the difficulty of the manoeuvre.

Any manoeuvre not completed, or flown out of sequence with the stated schedule, shall be scored zero (0). Zero scores need not be unanimous, except in cases where an entirely wrong manoeuvre was performed. Judges must confer after the flight in these cases, bringing it to the attention of the flight line director/contest director on site.

Take-off and landing procedures are not judged and are not scored.

The manoeuvring zone is vertically spread in front of and at a distance of approximately 150 m from the pilot. It is laterally limited by two virtual vertical planes above the extension of two lines on the ground each at an angle of 60 degrees left and right from the intersection of a centre line with the safety line. The centre line is positioned on the ground perpendicular to the safety line on the ground which is parallel to the runway. The upper limit of the manoeuvring zone is defined by the virtual plane stretching up 60 degrees from the ground at the intersection of all ground lines.

The pilot is normally placed on the intersection of all ground lines.

Manoeuvres must be performed where they can be seen clearly by the judges. If a judge, for some reason beyond the control of the competitor, is not able to follow the model aircraft through the entire manoeuvre, he may set the "Not Observed" (N.O.) mark. In this case, the judge's mark for that particular manoeuvre will be the average of the numerical marks given by the other judges, rounded to the nearest whole number. If no such average is achievable, the competitor has the right for a reflight as per paragraph 5.1.6.

Centre manoeuvres should be performed in the centre of the manoeuvring zone while turn around manoeuvres should not extend past the lateral limits. Vertical height should not exceed the upper limit. Also, manoeuvres should be performed along a line of flight approximately 150m in front of the security line. Infractions of this rule will be cause for downgrading by each judge individually and in proportion to the degree of infraction. Exceptions to this rule are the horizontal circle manoeuvres which, of necessity, may deviate from the 150m distance of flight.

The manoeuvring zone shall be clearly marked with white (or contrasting colour to the background) vertical poles, approximately 100mm in diameter and approximately 4m high, placed on centre and 60 degrees each side of centre on a line 150m in front of the competitor's position. Flags, streamers, or boards of contrasting colour to the background, should be mounted on the poles to improve visibility. White (or contrasting) lines, originating at the competitor's position and extending outward at least 50m, shall also be used to mark the centre and extreme limits (60 degrees left and right of centre) of the manoeuvring zone. Audible and visual signals to indicate violations of the manoeuvring zone must not be used.

The judges shall be seated not more than 10m, and not less than 7m behind the competitor's position (the apex of the 60 degree lines) and within an area described by the extension of the 60 degree lines to the rear of the competitor. The judges must be seated abreast, usually separated by 2m, with scribes or score secretaries separating them.

At the conclusion of the flight, each judge must independently consider if the in-flight sound level of the model aircraft is too loud. If a majority of the judges consider the in-flight sound level of the model aircraft to be too loud, then the flight score will be penalised by 10 points for each counting judge on that panel during the flight. If, during a flight, the sound level of the model aircraft increases perceptibly as a result of an equipment malfunction, or of a condition initiated by the competitor, the flight line director may request a sound re-test. If an equipment malfunction during the flight (such as mechanical failure of the exhaust/muffler system) causes excessive noise, the flight line director may request the competitor to land his model aircraft, and scoring will cease from the point of malfunction.

If a model aircraft is, in the opinion of the judges, unsafe or being flown in an unsafe or inappropriate manner, they may bring this to the attention of the flight line director, who may instruct the pilot to land.

cont/...

The individual manoeuvre scores given by each judge for each competitor must be made public at the end of each round of competition. The team manager must be afforded the opportunity to check that the scores on each judge's score sheet correspond to the tabulated scores (to avoid data capture errors). The score board must be located in a prominent position at the flight line, in full view of the competitors and the public.

All flight results before the completion of a round must be ranked alphabetically, or by country, or by contestant number, but not in order of performance or placing.

5.1.9. Classification

For World and Continental Championships, each competitor will have four preliminary (Schedule P) flights, with the best three normalised scores counting to determine the preliminary ranking. The top one third, but not more than 30 competitors, will then have two additional semi-final flights flying the known finals schedule. The total of the best three preliminary flights (normalised again to 1000 points) will count as one score along with the two semi-finals scores to provide three scores, the best two to count for semi-finals classification.

The top ten competitors of the semi-finals of a World or Continental Championship where there is an entry of more than 40 competitors, will then have four additional flights to determine the individual winner. For a World or Continental Championship with less than 40 competitors, the top five competitors will advance to the finals. Two final flights will be the current known finals schedule (F) and two will be unknown schedules (two different schedules, UK1 and UK2) (see 5.5). The known and unknown schedules must be flown in alternating sequence, starting with the known finals schedule (F). The best score from the known schedule will be combined with the scores from both unknown schedules for final classification. In the case of a tie the semi-final score will be used to decide the higher classification.

The team classification is established at the end of the competition (after the finals) by adding the numerical final placing of the best three team members of each nation. Teams are ranked from the lowest numerical scores to the highest, with complete three-competitor teams, ahead of two-competitor teams, which in turn are ranked ahead of one-competitor teams. In the case of a tie, the best individual placing decides the team ranking.

For World and Continental Championships, the scores for all rounds, preliminary, semi-finals and finals, will be computed using the Tarasov-Bauer-Long (TBL) statistical averaging scoring system. Only computer tabulation systems containing the TBL algorithm and judge analysis programs that have been approved by the CIAM Bureau can be used at World and Continental Championships.

All scores for each round, preliminary, semi-final and finals, will then be normalised as follows. When all competitors have flown in front of a particular group of judges (ie a round) the highest score shall be awarded 1000 points. The remaining scores for that group of judges are then normalised to a percentage of the 1000 points in the ratio of actual score over winner's score.

$$\text{Points}_x = \frac{S_x}{S_w} \times 1000$$

Points_x = points awarded to competitor X

S_x = score of competitor X

S_w = score of winner of round

Note 1: Final and semi-final flights to determine the individual winner are usually only required for World and Continental Championships. For open international events, national championships, and domestic competitions, the total of the three best preliminary flights out of four or the best two out of three may be used to determine the individual winner and team placing. Flights of Schedule F may be incorporated depending on local circumstances and the time available.

In the event of adverse weather conditions where no further flying is possible, the preliminary classification may be determined as follows:

One round/flight completed by each competitor: round/flight to count

Two rounds/flights completed by each competitor: best round/flight to count

Three rounds/flights completed by each competitor: best two rounds/flights to count

Four rounds/flights completed by each competitor: best three rounds/flights to count.

cont/...

Note 2: The TBL score tabulation system can only be applied for events with at least 5 competitors and 5 judges. For those smaller events that are not scored with the TBL system, the highest and lowest marks for each manoeuvre will be discarded if four or more judges are used.

5.1.10. Judging

For World Championships the organiser must appoint four panels of five judges each (a total of twenty judges). The judges must be of different nationalities and must be selected from a current list of FAI International Judges. Those selected must reflect the approximate geographical distribution of teams participating in the previous World Championship with the final list approved by the CIAM Bureau. At least one third, but not more than two thirds of the judges must not have judged at the previous World Championships. Judge assignment to the four panels will be by random draw.

The invited judges for a World or Continental Championship, must be selected from the current list of FAI International Judges and must have had a reasonable amount of F3A judging experience of both current P and F schedules, and must submit a résumé of his judging experience to the organiser during the nomination process. The organiser must in turn submit the résumés to the CIAM Bureau for approval.

For the semi-final rounds of a World Championship the judges will be arranged in two groups of ten judges. Assignment to the two groups will be by random draw.

For a World Championship with fewer than 72 competitors, and for a Continental Championship with 40 or more competitors, the organiser must appoint two panels of five judges each (a total of ten judges). The judges must be of different nationalities and must be selected from a current list of FAI International Judges. Judge assignment to the two panels will be by random draw.

For Continental Championships with fewer than 30 competitors, the organiser must appoint a single panel of five judges, with the same selection criteria as above.

For World Championships with fewer than 72 competitors, and for a Continental Championships with 30 or more entries, two panels of five judges may be used for the preliminary and semi-final rounds, and one panel of ten judges may be used for the final rounds. For a Continental Championship with fewer than 40 competitors, one panel of five judges may be used for preliminary, semi-final, and final rounds.

For open international events, where the TBL statistical averaging scoring system is not used, the highest and lowest marks for each manoeuvre may be discarded, but only where four or more judges are used. It is recommended that this is applied at national championships, and domestic competitions, too.

For the final rounds of a World Championship with 72 or more competitors, the twenty judges will be arranged in three groups, a left hand group of five judges to judge only the left turn-around manoeuvres, a centre group of ten judges to judge only the centre manoeuvres and a right hand group of five judges to judge only the right turn-around manoeuvres. Judge assignments to the three groups will be by random draw for rounds one and two (one known and one unknown round) with a second draw for rounds three and four, except a judge will not serve in the same group as in the previous draw. For each competitor, the score from the three groups (following TBL computation) will be combined for a total score for the flight.

Before every World or Continental Championship, there shall be a briefing for the judges, followed by training flights by non-competitors. Also, warm-up flights for the judges should be flown by non-competitors before the first official preliminary flight each day. For the semi-finals the highest placing non-semi-finalists and for the finals the highest placing two non-finalists should be awarded the honour of performing the warm-up flights. Warm-up flights should be judged but under no circumstances should they be tabulated. Any deviations from the above procedures must be stated in advance by the organisers and must have prior approval of the CIAM or the CIAM Bureau.

5.1.11. Organisation for Radio Controlled Aerobatics Contests

Members of a National team, who have processed only one model aircraft each, may make use of the second model aircraft processed by another member of the same team. However, once that model has been used by a team member in that competition, it may not be used by any other competitor. If that team member did not process the model aircraft in the first place, then it must be re-registered and re-marked appropriately. This is the responsibility of the team manager.

For transmitter and FM frequency control see Section 4B, paragraph B.11.

The draw for flight order will be done for each flight line, so that FM frequencies are separated with two competitors in between. Team members will not be drawn to fly directly after each other. Team members on separate flight lines will be separated by at least two competitors. Competitor identification numbers will only be assigned after this flight order draw, by competitor_group, and in numerical ascending order.

For flights two, three and four of the preliminary rounds the flight order will start $\frac{1}{4}$, $\frac{1}{2}$ and $\frac{3}{4}$ down the flight order respectively. Organisers must take care to avoid a flight draw which will cause competitors to fly at approximately the same time each day.

The flight order for the first semi-finals round will also be by random draw. The second semi-finals flight will start $\frac{1}{2}$ down the semi-finals flight order.

The flight order for the first round of the finals will be established by a random draw as above. The flight order for flights two, three and four will start $\frac{1}{4}$, $\frac{1}{2}$ and $\frac{3}{4}$ down the finals flight order with decimals rounded-up.

During the flight the competitor must stay in the proximity of the judges and under the supervision of the Flight Line Director.

Competitors must be called by a flight line official at least five minutes before they are required to occupy the starting area.

If the FM frequency is clear the competitor or his team manager will be allowed to collect the FM transmitter from the transmitter pound. The competitor and his helper(s) then occupy the starting area so that a radio check can be performed to verify the correct functioning of the radio control equipment. If there is a FM frequency conflict, the competitor must be allowed a maximum of one minute for a radio check before the beginning of the starting time.

The time keeper will audibly notify the competitor when the minute is finished and immediately begin timing the starting time.

According to paragraph 5.1.2., the voltage of the propulsion battery of electric powered models, must be checked by an official in the preparation area before the starting time is started.

For electric powered models, the electric power circuit(s) must not be physically connected, before the starting time is begun and must be physically disconnected immediately after landing.

A competitor is allowed two (2) minutes of starting time and eight (8) minutes of flying time for each flight. The timing of a flight starts with the starting time when the contest director, or timekeeper, gives an instruction to the competitor to start. The openly displayed timing device/clock will be stopped when the competitor is ready to take the sound measurement. The helpers who place the model aircraft, must ensure that the model aircraft is positioned as per paragraph 5.1.2. If the model aircraft is not placed correctly for the sound test before/at the 2-minute-mark, the contest director/time keeper will advise the competitor and helper that the flight may not proceed. The flight shall score zero points. When the contest director/sound steward is satisfied that he has obtained a reading from the SLM, he will indicate this to the competitor, and the timing device will be re-activated to start the 8-minute flying time. With the expiry of the 8-minute flying time, the scoring will cease except for the in-flight sound assessment, which is judged after the model aircraft has landed, irrespective of the time. The contest director/time keeper will advise the pilot, helper, and the judges of the expiry of the 8-minute flying time. The clock will be stopped when the wheels of the model aircraft touch the ground for landing, as proof to the competitor of the recorded time.

The competitor may not start his model aircraft unless he has been instructed by a flight line official to do so. Deliberate starts at the flight line during official flying to check the propulsion device will be subject to disqualification from that round. No public address or commentary should be made during flights.

During the flight, the pilot and his helper/caller (if required) must stay in the designated position in front of the judges, at the convergence of the ground lines and under the supervision of the flight line director. The pilot must wear or display his identification/start number.

5.1.12. Execution of Manoeuvres

The manoeuvres must be executed during an uninterrupted flight in the order in which they are listed in the schedule. The competitor may make only one attempt at each scored manoeuvre during the flight.

The model aircraft must take-off and land unassisted, that is, no hand launched flights. If any part of the model aircraft is jettisoned during the flight, scoring will cease at that point and the competitor must be instructed by the flight line director to immediately land his model aircraft. Usually, the judges will be able to determine when a part has been jettisoned from the model aircraft. They should bring this to the attention of the flight line director on site.

cont/...

The direction of the first manoeuvre or the landing may be different from that of the take-off.

After take-off, only turn-around manoeuvres, and not more than two (2), are allowed before starting the first manoeuvre of the schedule.

5.1.13. Schedule of Manoeuvres

For 2013-2014 Schedule A-14 is recommended to be flown in local competitions so as to offer advanced pilots a suitable way to achieve skills to step-up to P-15 Schedules.

For 2012-2013 Schedule P-13 will be flown in the preliminaries. Schedule F-13 will be flown in the semi-finals, as well as in the finals, alternating with unknown schedules.

For 2014-2015 Schedule P-15 will be flown in the preliminaries. Schedule F-15 will be flown in the semi-finals, as well as in the finals, alternating with unknown schedules.

Advanced Schedule A-14 (2013-2014)

	K-Factor
A-14.01 Golf Ball	K 3
A-14.02 Half Square Loop on Corner	K 3
A-14.03 Double Immelman with ½ roll, roll	K 5
A-14.04 Half Square Loop with ½ roll	K 2
A-14.05 Stall Turn with ¼ roll up, ¼ roll down	K 5
A-14.06 Reverse Cuban 8 with ½ roll	K 2
A-14.07 Roll Combination with consecutive three ¼ rolls, three ¼ rolls in opposite direction	K 5
A-14.08 Pull-Push-Pull Humpty-Bump with ¼ roll up, ¼ roll down (Option: ½ roll up)	K 4
A-14.09 Top Hat Spin with 3 turns	K 4
A-14.10 Pull-Pull-Push Humpty-Bump with 1/4 roll up, 1/4 roll down	K 4
A-14.11 Reverse Cuban 8 with roll, ½ roll	K 4
A-14.12 Figure 9 with roll up	K 3
A-14.13 Hour-Glass	K 4
A-14.14 Stall Turn with ½ roll down	K 3
A-14.15 45° Upline with slow roll	K 4
A-14.16 Split S with ½ roll	K 1
A-14.17 Avalanche with snap roll on top	K 4

Total	K 60

Preliminary Schedule P-13 (2012-2013)

	K-Factor
P-13.01 Half Clover Leaf with horizontal roll	K 3
P-13.02 Stall Turn with ¼ roll up, ¼ roll down	K 3
P-13.03 Roll Combination with consecutive three ¼ rolls, three ¼ rolls in opposite direction	K 4
P-13.04 Half Square Loop with consecutive two ½ rolls in opposite directions	K 3
P-13.05 Triangle with roll in each line	K 4
P-13.06 Split S with roll	K 2
P-13.07 45° Upline with 1½ snap roll	K 5
P-13.08 Reverse Top Hat with ¼ roll down, ¾ roll up	K 4
P-13.09 Spin with 2½ turns, 2½ turns in opposite direction	K 4
P-13.10 Pull-Push-Pull Humpty-Bump with ¼ roll up, ¼ roll down (Option: Consecutive two ¼ rolls up)	K 3
P-13.11 Cuban 8 with integrated rolls on top 90° of both part loops.	K 5
P-13.12 Half Loop	K 1
P-13.13 Square Loop with ½ roll in each line	K 5
P-13.14 Figure 9 with consecutive two ½ rolls	K 3
P-13.15 Roll Combination with consecutive ½ roll, roll, ½ rolls in opposite directions	K 4

cont/...

P-13.16 Half Loop on Corner with $\frac{1}{4}$ roll, $\frac{1}{4}$ knife-edge loop, $\frac{1}{4}$ roll	K 3
P-13.17 Figure Z with consecutive four $\frac{1}{8}$ rolls	K 4

Total	K 60

Preliminary Schedule P-15 (2014-2015)**K-Factor**

P-15.01 Golf Ball with two $\frac{1}{2}$ rolls	K 3
P-15.02 Half Square Loop on Corner with $\frac{1}{2}$ roll	K 3
P-15.03 Double Immelman with two knife-edge flights	K 5
P-15.04 Half Square Loop with $\frac{1}{2}$ roll	K 2
P-15.05 Stall Turn with $1\frac{1}{4}$ roll up, $\frac{3}{4}$ roll down	K 5
P-15.06 Half Reverse Cuban 8 with $\frac{1}{2}$ roll	K 2
P-15.07 Roll Combination with consecutive three $\frac{1}{6}$ rolls, three $\frac{1}{6}$ rolls in opposite direction	K 5
P-15.08 Pull-Push-Push Humpty-Bump with $\frac{3}{4}$ roll up, $\frac{3}{4}$ roll down (Option: $\frac{1}{2}$ roll up, $\frac{1}{2}$ roll down)	K 4
P-15.09 Top Hat Inverted Spin with $2\frac{1}{2}$ turns	K 4
P-15.10 Pull-Knife-Edge-Push Humpty-Bump with $\frac{1}{2}$ roll down	K 4
P-15.11 Reverse Cuban 8 with consecutive two $\frac{1}{4}$ rolls, consecutive two $\frac{1}{2}$ rolls in opposite directions	K 4
P-15.12 Figure 9 with consecutive four $\frac{1}{4}$ rolls up	K 3
P-15.13 Hour-Glass with $\frac{1}{2}$ roll, roll, $\frac{1}{2}$ roll	K 4
P-15.14 Stall Turn with consecutive two $\frac{1}{4}$ rolls down	K 3
P-15.15 45° Upline with consecutive two rolls in opposite directions	K 4
P-15.16 Split S with $\frac{1}{2}$ roll	K 1
P-15.17 Avalanche with snap roll on top	K 4

Total	K 60

Semi-Final and Final Schedule F-13 (2012-2013)**K-Factor**

F-13.01 Humpty-Bump with $\frac{3}{4}$ roll up, $\frac{1}{2}$ knife-edge loop, $\frac{3}{4}$ roll down	K 4
F-13.02 Half Square Loop with consecutive $\frac{1}{2}$ roll, roll in opposite direction	K 3
F-13.03 Loop with consecutive four $\frac{1}{2}$ rolls in opposite directions integrated	K 6
F-13.04 Figure 6 with stall turn, consecutive two $\frac{1}{4}$ rolls down	K 4
F-13.05 Roll Combination with consecutive $\frac{1}{4}$ roll, two snap rolls in opposite directions, $\frac{1}{4}$ roll	K 6
F-13.06 Shark Fin with roll up, consecutive two $\frac{1}{4}$ rolls down	K 3
F-13.07 Horizontal Circle 8 with consecutive two rolls	K 5
F-13.08 Pull-Push-Pull Humpty-Bump with consecutive four $\frac{1}{4}$ rolls up, $1\frac{1}{2}$ roll down	K 3
F-13.09 45° Upline with consecutive four $\frac{1}{8}$ rolls, $1\frac{1}{2}$ snap roll in opposite direction	K 5
F-13.10 Reverse Top Hat with $\frac{3}{4}$ roll down, $\frac{1}{4}$ rolls up (Option: roll down, consecutive two $\frac{1}{4}$ rolls up)	K 3
F-13.11 Clown Dance with $\frac{1}{2}$ loop, inverted spin, $2\frac{1}{2}$ turns, consecutive two $\frac{1}{4}$ rolls down	K 5
F-13.12 Fighter Turn with two $\frac{1}{4}$ rolls	K 4
F-13.13 Knife-Edge Loop with integrated roll on top 90°	K 4
F-13.14 Reverse Cuban 8 with snap roll up	K 4
F-13.15 Triangle with consecutive two $\frac{1}{4}$ rolls in each line	K 4
F-13.16 Half Loop with roll integrated	K 3
F-13.17 45° Downline with consecutive two $\frac{1}{8}$ roll, roll, two $\frac{1}{8}$ roll in opposite directions	K 4

Total	K 70

cont/...

Semi-Final and Final Schedule F-15 (2014-2015)**K-Factor**

F-15.01 Double Immelman with $\frac{1}{2}$ rolls in both $\frac{1}{2}$ loops integrated, two consecutive two $\frac{1}{4}$ rolls in opposite direction to integrated rolls.	K 4
F-15.02 Stall Turn with consecutive three $\frac{1}{4}$ rolls up, 1 $\frac{1}{4}$ snap rolls down	K 3
F-15.03 Golf Ball with $\frac{3}{4}$ roll up, knife-edge loop with snap roll, $\frac{3}{4}$ roll down	K 5
F-15.04 Half Square Loop with consecutive two snap rolls in opposite directions	K 4
F-15.05 Loop with consecutive two $\frac{1}{2}$ rolls in opposite directions integrated	K 4
F-15.06 Inverted Spin with $2\frac{1}{2}$ turns, $\frac{1}{2}$ roll down	K 3
F-15.07 Horizontal Triangular Circle with $\frac{1}{4}$ roll, $\frac{1}{2}$ outside rolls in each corner integrated $\frac{1}{4}$ roll	K 6
F-15.08 Top Hat with consecutive two $\frac{1}{4}$ rolls up, snap roll down (Option: Consecutive three $\frac{1}{4}$ rolls up, $1\frac{1}{4}$ snap roll down)	K 4
F-15.09 Vertical Cuban 8 with consecutive four $\frac{1}{8}$ rolls up, consecutive two $\frac{1}{2}$ rolls down	K 4
F-15.10 Half Square Loop on Corner with $\frac{1}{2}$ roll integrated in $\frac{1}{4}$ loop	K 4
F-15.11 Horizontal Hour-Glass with consecutive two $\frac{1}{4}$ rolls, two $\frac{1}{4}$ rolls in opposite direction consecutive two $\frac{3}{4}$ rolls in opposite directions	K 4
F-15.12 Half Square Loop with consecutive two $\frac{1}{2}$ rolls	K 3
F-15.13 Figure 9 with consecutive four $\frac{1}{4}$ rolls up, $\frac{3}{4}$ loop with roll integrated in top 180°	K 6
F-15.14 Split S with $1\frac{1}{2}$ snap roll	K 3
F-15.15 Roll Combination with consecutive four rolls in opposite directions	K 5
F-15.16 Pull-Pull-Push Humpty-Bump with two $\frac{1}{2}$ roll in opposite direction up, roll down	K 3
F-15.17 Stall Turn with consecutive six $\frac{1}{8}$ rolls up, $1\frac{3}{4}$ snap roll down	K 5

	Total K 70

ANNEX 5A**F3A – RADIO CONTROLLED AEROBATIC MODEL AIRCRAFT
DESCRIPTION OF MANOEUVRES****ADVANCED SCHEDULE A-14 (2013-2014)****A-14.01 Golf Ball**

From upright, pull through a $\frac{1}{8}$ loop into a 45° upline, pull through a $\frac{3}{4}$ loop into a 45° downline, pull through a $\frac{1}{8}$ loop, exit upright.

A-14.02 Half Square Loop on Corner

From upright, pull through a $\frac{1}{8}$ loop into a 45° upline, pull through a $\frac{1}{4}$ loop into a 45° upline, pull through a $\frac{1}{8}$ loop, exit inverted.

A-14.03 Double Immelman with $\frac{1}{2}$ roll, roll

From inverted pull through a $\frac{1}{2}$ loop immediately followed by a $\frac{1}{2}$ roll, perform a horizontal line, push through a $\frac{1}{2}$ loop immediately followed by a roll, perform a horizontal line, exit upright.

A-14.04 Half Square Loop with $\frac{1}{2}$ roll

From upright push through a $\frac{1}{4}$ loop into a vertical downline, perform a $\frac{1}{2}$ roll, pull through a $\frac{1}{4}$ loop, exit upright.

A-14.05 Stall Turn with $\frac{1}{4}$ roll up, $\frac{1}{4}$ roll down

From upright, pull through a $\frac{1}{4}$ loop into a vertical upline, perform a $\frac{1}{4}$ roll, perform a stall turn into a vertical downline, perform a $\frac{1}{4}$ roll down, pull through a $\frac{1}{4}$ loop, exit upright.

A-14.06 Reverse Cuban 8 with $\frac{1}{2}$ roll

From upright pull through a $\frac{1}{8}$ loop into a 45° upline, perform a $\frac{1}{2}$ roll, pull through a $\frac{5}{8}$ loop, exit upright.

A-14.07 Roll Combination with consecutive three $\frac{1}{4}$ rolls, three $\frac{1}{4}$ rolls in opposite direction

From upright, perform consecutively three $\frac{1}{4}$ rolls, three $\frac{1}{4}$ rolls in opposite direction, exit upright.

A-14.08 Pull-Push-Pull Humpty-Bump with $\frac{1}{4}$ roll up, $\frac{1}{4}$ roll down (Option: $\frac{1}{2}$ roll up)

From upright, pull through a $\frac{1}{4}$ loop into a vertical upline, perform a $\frac{1}{4}$ roll, push through a $\frac{1}{2}$ loop into a vertical downline, perform a $\frac{1}{4}$ roll, pull through a $\frac{1}{4}$ loop, exit upright.

Option: From upright, pull through a $\frac{1}{4}$ loop into a vertical upline, perform a $\frac{1}{2}$ roll, push through a $\frac{1}{2}$ loop into a vertical downline, pull through a $\frac{1}{4}$ loop, exit upright.

A-14.09 Top Hat Spin with 3 turns

From upright pull through a $\frac{1}{4}$ loop into a vertical upline, push through a $\frac{1}{4}$ loop into a horizontal line, perform an upright spin with 3 turns, perform a vertical downline, pull through a $\frac{1}{4}$ loop, exit upright.

A-14.10 Pull-Pull-Push Humpty-Bump with $\frac{1}{4}$ roll up, $\frac{1}{4}$ roll down

From upright, pull through a $\frac{1}{4}$ loop into a vertical upline, perform a $\frac{1}{4}$ roll, pull through a $\frac{1}{2}$ loop into a vertical downline, perform a $\frac{1}{4}$ roll, push through a $\frac{1}{4}$ loop, exit inverted.

A-14.11 Reverse Cuban 8 with roll, $\frac{1}{2}$ roll

From inverted, push through a $\frac{1}{8}$ loop into a 45° upline, perform a roll, pull through a $\frac{3}{4}$ loop into another 45° upline, perform a $\frac{1}{2}$ roll, pull through a $\frac{5}{8}$ loop, exit upright.

A-14.12 Figure 9 with roll up

From upright, pull through a $\frac{1}{4}$ loop into a vertical upline, perform a roll, push through a $\frac{3}{4}$ loop, exit inverted.

A-14.13 Hour-Glass

From inverted, push through a $\frac{1}{8}$ loop into a 45° upline, push through a $\frac{3}{8}$ loop into a horizontal line, push through a $\frac{3}{8}$ loop into a 45° downline, pull through a $\frac{3}{8}$ loop into a horizontal line, pull through a $\frac{3}{8}$ loop into a 45° upline, pull through a $\frac{1}{8}$ loop, exit inverted.

cont/...

A-14.14 Stall Turn with ½ roll down

From inverted, push through a ¼ loop into a vertical upline, perform a stall turn into a vertical downline, perform a ½ roll, pull through a ¼ loop, exit upright.

A-14.15 45° Upline with slow roll

From upright, pull through a ⅛ loop into a 45° upline, perform a slow roll, push through a ⅛ loop, exit upright.

A-14.16 Split S with ½ roll

From upright, perform a ½ roll and immediately pull through a ½ loop, exit upright.

A-14.17 Avalanche with snap roll on top

From upright, pull through a loop while performing a snap roll on the top of the loop, exit upright.

PRELIMINARY SCHEDULE P-13 (2012-2013)

P-13.01 Half Clover Leaf with horizontal roll

From upright, pull through a ¼ loop into a vertical upline, push through a ¾ loop into a horizontal line, perform a roll, push through a ¾ loop into a vertical downline, pull through a ¼ loop, exit upright.

P-13.02 Stall Turn with ¼ roll up, ¼ roll down

From upright, pull through a ¼ loop into a vertical upline, perform a ¼ roll, perform a stall turn into a vertical downline, perform a ¼ roll, push through a ¼ loop, exit inverted.

P-13.03 Roll Combination with consecutive three ¼ rolls, three ¼ rolls in opposite direction

From inverted, perform consecutively three ¼ rolls, three ¼ rolls in opposite direction, exit inverted.

P-13.04 Half Square Loop with consecutive two ½ rolls in opposite directions

From inverted, push through a ¼ loop into a vertical upline, perform consecutively two ½ rolls in opposite directions, push through a ¼ loop, exit upright.

P-13.05 Triangle with roll in each line

From upright, push through a ⅛ loop into a 45° downline, perform a roll, push through a 3/8 loop into a horizontal line, perform a roll, push through a 3/8 loop into a 45° upline, perform a roll, push through a ⅛ loop, exit upright.

P-13.06 Split S with roll

From upright, perform a roll and immediately push through a ½ loop, exit inverted.

P-13.07 45° Upline with 1½ snap roll

From inverted, push through a ⅛ loop into a 45° upline, perform 1½ snap roll, push through a ⅛ loop, exit upright.

P-13.08 Reverse Top Hat with ¼ roll down, ¾ roll up

From upright, push through a ¼ loop into a vertical downline, perform a ¼ roll, push through a ¼ loop into a horizontal line, push through a ¼ loop into a vertical upline, perform a ¾ roll, push through a ¼ loop, exit upright.

P-13.09 Spin with 2½ turns, 2½ turns in opposite direction

From upright, perform a upright spin with 2½ turns immediately followed by another 2½ turns in the opposite direction, perform a vertical downline, pull through a ¼ loop, exit upright.

P-13.10 Pull-Push-Pull Humpty-Bump with ¼ roll up, ¼ roll down (Option: Consecutive two ¼ rolls up)

From upright, pull through a ¼ loop into a vertical upline, perform a ¼ roll, push through a ½ loop into a vertical downline, perform a ¼ roll, pull through a ¼ loop, exit upright.

Option: From upright, pull through a ¼ loop into a vertical upline, perform consecutively two ¼ rolls, push through a ½ loop into a vertical downline, pull through a ¼ loop, exit upright.

P-13.11 Cuban 8 with integrated rolls on top 90° of both part loops.

From upright, pull through a 5/8 loop into a 45° downline while performing an integrated roll in the top 90° of the loop, push through a ¾ loop into another 45° downline while performing an integrated roll in the top 90° of the loop, pull through a ⅛ loop, exit upright.

cont/...

P-13.12 Half Loop

From upright, pull through a $\frac{1}{2}$ loop, exit inverted.

P-13.13 Square Loop with $\frac{1}{2}$ roll in each line

From inverted, pull through a $\frac{1}{4}$ loop into a vertical downline, perform a $\frac{1}{2}$ roll, push through a $\frac{1}{4}$ loop into a horizontal line, perform a $\frac{1}{2}$ roll, pull through a $\frac{1}{4}$ loop into a vertical upline, perform a $\frac{1}{2}$ roll, push through a $\frac{1}{4}$ loop into a horizontal line, perform a $\frac{1}{2}$ roll, exit inverted.

P-13.14 Figure 9 with consecutive two $\frac{1}{2}$ rolls

From inverted, push through a $\frac{3}{4}$ loop into a vertical downline, perform consecutively two $\frac{1}{2}$ rolls, pull through a $\frac{1}{4}$ loop, exit upright.

P-13.15 Roll Combination with consecutive $\frac{1}{2}$ roll, roll, $\frac{1}{2}$ rolls in opposite directions

From upright, perform consecutively a $\frac{1}{2}$ roll, a roll in opposite direction, a $\frac{1}{2}$ roll in opposite direction, exit upright.

P-13.16 Half Loop on Corner with $\frac{1}{4}$ roll, $\frac{1}{4}$ knife-edge loop, $\frac{1}{4}$ roll

From upright pull through a $\frac{1}{8}$ loop into a 45° upline, perform $\frac{1}{4}$ roll, perform $\frac{1}{4}$ knife-edge loop into 45° upline, perform $\frac{1}{4}$ roll, pull through a $\frac{1}{8}$ loop, exit inverted.

P-13.17 Figure Z with consecutive four $\frac{1}{8}$ rolls

From inverted, pull through a $\frac{3}{8}$ loop into a 45° downline, perform consecutively four $\frac{1}{8}$ rolls, pull through a $\frac{3}{8}$ loop, exit upright.

PRELIMINARY SCHEDULE P-15 (2014-2015)**P-15.01 Golf Ball with two $\frac{1}{2}$ rolls**

From upright, pull through a $\frac{1}{8}$ loop into a 45° upline, perform a $\frac{1}{2}$ roll, push through a $\frac{3}{4}$ loop into a 45° downline, perform a $\frac{1}{2}$ roll, pull through a $\frac{1}{8}$ loop, exit upright.

P-15.02 Half Square Loop on Corner with $\frac{1}{2}$ roll

From upright, pull through a $\frac{1}{8}$ loop into a 45° upline, pull through a $\frac{1}{4}$ loop into a 45° upline, perform a $\frac{1}{2}$ roll, push through a $\frac{1}{8}$ loop, exit upright.

P-15.03 Double Immelman with two knife-edge flights

From upright push through a $\frac{1}{2}$ loop immediately followed by a $\frac{1}{4}$ roll, perform a horizontal knife-edge flight, perform a $\frac{1}{4}$ roll and immediately pull through a $\frac{1}{2}$ loop immediately followed by a $\frac{1}{4}$ roll, perform a horizontal knife-edge flight, perform a $\frac{1}{4}$ roll, exit upright.

P-15.04 Half Square Loop with $\frac{1}{2}$ roll

From upright push through a $\frac{1}{4}$ loop into a vertical downline, perform a $\frac{1}{2}$ roll, pull through a $\frac{1}{4}$ loop, exit upright.

P-15.05 Stall Turn with $1\frac{1}{4}$ roll up, $\frac{3}{4}$ roll down

From upright, pull through a $\frac{1}{4}$ loop into a vertical upline, perform a $1\frac{1}{4}$ roll, perform a stall turn into a vertical downline, perform a $\frac{3}{4}$ roll down, pull through a $\frac{1}{4}$ loop, exit upright.

P-15.06 Half Reverse Cuban 8 with $\frac{1}{2}$ roll

From upright pull through a $\frac{1}{8}$ loop into a 45° upline, perform a $\frac{1}{2}$ roll, pull through a $\frac{5}{8}$ loop, exit upright.

P-15.07 Roll Combination with consecutive three $\frac{1}{6}$ rolls, three $\frac{1}{6}$ rolls in opposite direction

From upright, perform consecutively three $\frac{1}{6}$ rolls, three $\frac{1}{6}$ rolls in opposite direction, exit upright.

P-15.08 Pull-Push-Push Humpty-Bump with $\frac{3}{4}$ roll up, $\frac{3}{4}$ roll down (Option: $\frac{1}{2}$ roll up, $\frac{1}{2}$ roll down)

From upright, pull through a $\frac{1}{4}$ loop into a vertical upline, perform a $\frac{3}{4}$ roll, push through a $\frac{1}{2}$ loop into a vertical downline, perform a $\frac{3}{4}$ roll, push through a $\frac{1}{4}$ loop, exit inverted.

Option: From upright, pull through a $\frac{1}{4}$ loop into a vertical upline, perform a $\frac{1}{2}$ roll, push through a $\frac{1}{2}$ loop into a vertical downline, perform a $\frac{1}{2}$ roll, push through a $\frac{1}{4}$ loop, exit inverted.

P-15.09 Top Hat Inverted Spin with $2\frac{1}{2}$ turns

From inverted push through a $\frac{1}{4}$ loop into a vertical upline, pull through a $\frac{1}{4}$ loop into a horizontal line, perform an inverted spin with $2\frac{1}{2}$ turns, perform a vertical downline, pull through a $\frac{1}{4}$ loop, exit upright.

P-15.10 Pull-Knife-Edge-Push Humpty-Bump with $\frac{1}{2}$ roll down

From upright, pull through a $\frac{1}{4}$ loop into a vertical upline, perform a $\frac{1}{2}$ loop in knife-edge flight into a vertical downline, perform a $\frac{1}{2}$ roll, push through a $\frac{1}{4}$ loop, exit inverted.

P-15.11 Reverse Cuban 8 with consecutive two $\frac{1}{4}$ rolls, consecutive two $\frac{1}{2}$ rolls in opposite directions

From inverted, push through a $\frac{1}{8}$ loop into a 45° upline, perform consecutively two $\frac{1}{4}$ rolls, push through a $\frac{3}{4}$ loop into another 45° upline, perform consecutively two $\frac{1}{2}$ rolls in opposite directions, pull through a $\frac{5}{8}$ loop, exit upright.

P-15.12 Figure 9 with consecutive four $\frac{1}{4}$ rolls up

From upright, pull through a $\frac{1}{4}$ loop into a vertical upline, perform consecutively four $\frac{1}{4}$ rolls, push through a $\frac{3}{4}$ loop, exit inverted.

P-15.13 Hour-Glass with $\frac{1}{2}$ roll, roll, $\frac{1}{2}$ roll

From inverted, push through a $\frac{1}{8}$ loop into a 45° upline, push through a $\frac{3}{8}$ loop into a horizontal line, perform a $\frac{1}{2}$ roll, pull through a $\frac{3}{8}$ loop into a 45° downline, perform a roll, push through a $\frac{3}{8}$ loop into a horizontal line, perform a $\frac{1}{2}$ roll, pull through a $\frac{3}{8}$ loop into a 45° upline, pull through a $\frac{1}{8}$ loop, exit inverted.

P-15.14 Stall Turn with consecutive two $\frac{1}{4}$ rolls down

From inverted, push through a $\frac{1}{4}$ loop into a vertical upline, perform a stall turn into a vertical downline, perform consecutively two $\frac{1}{4}$ rolls, pull through a $\frac{1}{4}$ loop, exit upright.

P-15.15 45° Upline with consecutive two rolls in opposite directions

From upright, pull through a $\frac{1}{8}$ loop into a 45° upline, perform consecutively two rolls in opposite directions, push through a $\frac{1}{8}$ loop, exit upright.

P-15.16 Split S with $\frac{1}{2}$ roll

From upright, perform a $\frac{1}{2}$ roll and immediately pull through a $\frac{1}{2}$ loop, exit upright.

P-15.17 Avalanche with snap roll on top

From upright, pull through a loop while performing a snap roll on the top of the loop, exit upright.

SEMI-FINAL AND FINAL SCHEDULE F-13 (2012-2013)

F-13.01 Humpty-Bump with $\frac{3}{4}$ roll up, $\frac{1}{2}$ knife-edge loop, $\frac{3}{4}$ roll down

From upright, pull through a $\frac{1}{4}$ loop into a vertical upline, perform a $\frac{3}{4}$ roll, perform a $\frac{1}{2}$ loop in knife-edge flight into a vertical downline, perform a $\frac{3}{4}$ roll, push through a $\frac{1}{4}$ loop, exit inverted.

F-13.02 Half Square Loop with consecutive $\frac{1}{2}$ roll, roll in opposite direction

From inverted, push through a $\frac{1}{4}$ loop into a vertical upline, perform consecutively a $\frac{1}{2}$ roll, a roll in opposite direction, pull through a $\frac{1}{4}$ loop, exit inverted.

F-13.03 Loop with consecutive four $\frac{1}{2}$ rolls in opposite directions integrated

From inverted, pull through a loop while performing consecutively four $\frac{1}{2}$ rolls in opposite directions, integrated in each 90° of the loop, exit inverted.

F-13.04 Figure 6 with stall turn, consecutive two $\frac{1}{4}$ rolls down

From inverted, pull through a $\frac{3}{4}$ loop into a vertical upline, perform a stall turn into a vertical downline, perform consecutively two $\frac{1}{4}$ rolls, pull through a $\frac{1}{4}$ loop, exit upright.

F-13.05 Roll Combination with consecutive $\frac{1}{4}$ roll, two snap rolls in opposite directions, $\frac{1}{4}$ roll

From upright, perform consecutively a $\frac{1}{4}$ roll, a snap roll, another snap roll in opposite direction, and a $\frac{1}{4}$ roll, exit upright.

F-13.06 Shark Fin with roll up, consecutive two $\frac{1}{4}$ rolls down

From upright, pull through a $\frac{1}{8}$ loop into a 45° upline, perform a roll, push through a $\frac{3}{8}$ loop into a vertical downline, perform consecutively two $\frac{1}{4}$ rolls, pull through a $\frac{1}{4}$ loop, exit upright.

cont/...

F-13.07 Horizontal Circle 8 with consecutive two rolls

From upright, perform a $\frac{1}{4}$ horizontal circle while performing the first $\frac{1}{4}$ of consecutive two rolls to the outside, then while continuing the rolling ($\frac{1}{4}$ of the rolls per $\frac{1}{4}$ of the circles), perform immediately another (full) circle in the opposite direction, then, while continuing the rolling accordingly finish the remaining $\frac{3}{4}$ of the first circle, exit upright.

F-13.08 Pull-Push-Pull Humpty-Bump with consecutive four $\frac{1}{4}$ rolls up, $1\frac{1}{2}$ roll down

From upright, pull through a $\frac{1}{4}$ loop into a vertical upline, perform consecutively four $\frac{1}{4}$ rolls, push through a $\frac{1}{2}$ loop into a vertical downline, perform a $1\frac{1}{2}$ roll, pull through a $\frac{1}{4}$ loop, exit upright.

F-13.09 45° Upline with consecutive four $\frac{1}{8}$ rolls, $1\frac{1}{2}$ snap roll in opposite direction

From upright, pull through a $\frac{1}{8}$ loop into a 45° upline, perform consecutively four $\frac{1}{8}$ rolls, and $1\frac{1}{2}$ snap roll in opposite direction, push through a $\frac{1}{8}$ loop, exit upright.

F-13.10 Reverse Top Hat with $\frac{3}{4}$ roll down, $\frac{1}{4}$ rolls up (Option: roll down, consecutive two $\frac{1}{4}$ rolls up)

From upright, push through a $\frac{1}{4}$ loop into a vertical downline, perform a $\frac{3}{4}$ roll, push through a $\frac{1}{4}$ loop into a horizontal line, push through a $\frac{1}{4}$ loop into a vertical upline, perform a $\frac{1}{4}$ roll, push through a $\frac{1}{4}$ loop, exit upright.

Option: From upright, push through a $\frac{1}{4}$ loop into a vertical downline, perform a roll, push through a $\frac{1}{4}$ loop into a horizontal line, push through a $\frac{1}{4}$ loop into a vertical upline, perform consecutively two $\frac{1}{4}$ rolls, push through a $\frac{1}{4}$ loop, exit upright.

F-13.11 Clown Dance with $\frac{1}{2}$ loop, inverted spin, $2\frac{1}{2}$ turns, consecutive two $\frac{1}{4}$ rolls down

From upright, pull through a $\frac{1}{2}$ loop into a horizontal line, perform an inverted spin with $2\frac{1}{2}$ turns, perform a vertical downline, perform consecutively two $\frac{1}{4}$ rolls, pull through a $\frac{1}{4}$ loop, exit upright.

F-13.12 Fighter Turn with two $\frac{1}{4}$ rolls

From upright, pull through a $\frac{1}{8}$ loop into a 45° upline, perform a $\frac{1}{4}$ roll, push through $\frac{1}{2}$ circle, to a 45° downline, perform a $\frac{1}{4}$ roll, pull through a $\frac{1}{8}$ loop, exit upright.

F-13.13 Knife-Edge Loop with integrated roll on top 90°

From upright, perform a $\frac{1}{4}$ roll, perform a loop in knife-edge flight while performing a roll integrated in the top 90° of the loop, perform a $\frac{1}{4}$ roll, exit upright.

F-13.14 Half Reverse Cuban 8 with snap roll up

From upright, pull through a $\frac{1}{8}$ loop into a 45° upline, perform a snap roll, push through a $\frac{5}{8}$ loop, exit inverted.

F-13.15 Triangle with consecutive two $\frac{1}{4}$ rolls in each line

From inverted, push through a $\frac{3}{8}$ loop into a 45° upline, perform consecutively two $\frac{1}{4}$ rolls, pull through a $\frac{1}{4}$ loop into a 45° downline, perform consecutively two $\frac{1}{4}$ rolls, push through a $\frac{3}{8}$ loop into a horizontal line, perform consecutively two $\frac{1}{4}$ rolls, exit upright.

F-13.16 Half Loop with roll integrated

From upright, pull through a $\frac{1}{2}$ loop, while performing a roll integrated, exit inverted.

F-13.17 45° Downline with consecutive two $\frac{1}{8}$ roll, roll, two $\frac{1}{8}$ roll in opposite directions

From inverted, pull through a $\frac{1}{8}$ loop into a 45° downline, perform consecutively two $\frac{1}{8}$ rolls, a roll in opposite direction, and another consecutive two $\frac{1}{8}$ rolls in opposite direction, pull through a $\frac{1}{8}$ loop, exit upright.

SEMI-FINAL AND FINAL SCHEDULE F-15 (2014-2015)**F-15.01 Double Immelman with $\frac{1}{2}$ rolls in both $\frac{1}{2}$ loops integrated, two consecutive two $\frac{1}{4}$ rolls in opposite direction to integrated rolls.**

From upright, pull through a $\frac{1}{2}$ loop while performing a $\frac{1}{2}$ roll integrated, immediately followed by consecutive two $\frac{1}{4}$ rolls in opposite direction to the integrated roll, perform a horizontal line, pull through a $\frac{1}{2}$ loop while performing a $\frac{1}{2}$ roll integrated, immediately followed by consecutive two $\frac{1}{4}$ rolls in opposite direction to the integrated roll, exit upright.

F-15.02 Stall Turn with consecutive three $\frac{1}{4}$ rolls up, $1\frac{1}{4}$ snap rolls down

From upright, pull through a $\frac{1}{4}$ loop into a vertical upline, perform consecutively three $\frac{1}{4}$ rolls, perform a stall turn into a vertical downline, perform $1\frac{1}{4}$ snap roll, push through a $\frac{1}{4}$ loop, exit inverted.

F-15.03 Golf Ball with $\frac{3}{4}$ roll up, knife-edge loop with snap roll, $\frac{3}{4}$ roll down

From inverted, push through a $\frac{1}{8}$ loop into a 45° upline, perform a $\frac{3}{4}$ roll, perform a $\frac{3}{4}$ loop in knife-edge flight with a snap roll on top into a 45° downline, perform a $\frac{3}{4}$ roll, pull through a $\frac{1}{8}$ loop, exit upright.

F-15.04 Half Square Loop with consecutive two snap rolls in opposite directions

From upright, pull through a $\frac{1}{4}$ loop into a vertical upline, perform consecutively two snap rolls and in opposite directions, pull through a $\frac{1}{4}$ loop, exit inverted.

F-15.05 Loop with consecutive two $\frac{1}{2}$ rolls in opposite directions integrated

From inverted, pull through a loop while performing a $\frac{1}{2}$ roll integrated in the first 180° of the loop and another $\frac{1}{2}$ roll in opposite direction integrated in the second 180° of the loop, exit inverted.

F-15.06 Inverted Spin with $2\frac{1}{2}$ turns, $\frac{1}{2}$ roll down

From inverted, perform an inverted spin with $2\frac{1}{2}$ turns, perform a vertical downline, perform a $\frac{1}{2}$ roll, pull through a $\frac{1}{4}$ loop, exit upright.

F-15.07 Horizontal Triangular Circle with $\frac{1}{4}$ roll, $\frac{1}{2}$ outside rolls in each corner integrated $\frac{1}{4}$ roll

From upright, perform a $\frac{1}{4}$ roll in the centre, perform a horizontal triangular circle of equal side lengths while performing a $\frac{1}{2}$ roll to the outside in each corner integrated, perform a $\frac{1}{4}$ roll in the centre, exit upright.

F-15.08 Top Hat with consecutive two $\frac{1}{4}$ rolls up, snap roll down (Option: Consecutive three $\frac{1}{4}$ rolls up, $1\frac{1}{4}$ snap roll down)

From upright, pull through a $\frac{1}{4}$ loop into a vertical upline, perform consecutively two $\frac{1}{4}$ rolls, pull through a $\frac{1}{4}$ loop into a horizontal line, pull through a $\frac{1}{4}$ loop into a vertical down line, perform a snap roll, pull through a $\frac{1}{4}$ loop, exit upright.

Option: From upright, pull through a $\frac{1}{4}$ loop into a vertical upline, perform consecutively three $\frac{1}{4}$ rolls, pull through a $\frac{1}{4}$ loop into a horizontal line, pull through a $\frac{1}{4}$ loop into a vertical down line, perform a $1\frac{1}{4}$ snap roll, pull through a $\frac{1}{4}$ loop, exit upright

F-15.09 Vertical Cuban 8 with consecutive four $\frac{1}{8}$ rolls up, consecutive two $\frac{1}{2}$ rolls down

From upright, pull through a $\frac{3}{8}$ loop into a 45° upline, perform consecutively four $\frac{1}{8}$ rolls, pull through a $\frac{3}{4}$ loop into a 45° downline, perform consecutively two $\frac{1}{2}$ rolls, push through a $\frac{3}{8}$ loop, exit inverted.

F-15.10 Half Square Loop on Corner with $\frac{1}{2}$ roll integrated in $\frac{1}{4}$ loop

From inverted, push through a $\frac{1}{8}$ loop into a 45° upline, push through a $\frac{1}{4}$ loop into a 45° upline, while performing a $\frac{1}{2}$ roll integrated in the $\frac{1}{4}$ loop, pull through a $\frac{1}{8}$ loop, exit inverted.

F-15.11 Horizontal Hour-Glass with consecutive two $\frac{1}{4}$ rolls, two $\frac{1}{4}$ rolls in opposite direction, consecutive two $\frac{3}{4}$ rolls in opposite directions

From inverted, pull through a $\frac{1}{4}$ loop into a vertical downline, pull through a $\frac{3}{8}$ loop into a 45° upline, perform consecutively two $\frac{1}{4}$ rolls, two $\frac{1}{4}$ rolls in opposite direction, push through a $\frac{3}{8}$ loop into a vertical downline, push through a $\frac{3}{8}$ loop into a 45° upline, perform consecutively two $\frac{3}{4}$ rolls in opposite directions, pull through a $\frac{1}{8}$ loop, exit inverted.

F-15.12 Half Square Loop with consecutive two $\frac{1}{2}$ rolls

From inverted, pull through a $\frac{1}{4}$ loop into a vertical downline, perform consecutively two $\frac{1}{2}$ rolls, pull through a $\frac{1}{4}$ loop, exit upright.

F-15.13 Figure 9 with consecutive four $\frac{1}{4}$ rolls up, $\frac{3}{4}$ loop with roll integrated in top 180°

From upright, pull through a $\frac{1}{4}$ loop into a vertical upline, perform consecutively four $\frac{1}{4}$ rolls, pull through a $\frac{3}{4}$ loop while performing a roll integrated in the top 180° of the $\frac{3}{4}$ loop, exit upright.

F-15.14 Split S with $1\frac{1}{2}$ snap roll

From upright, perform $1\frac{1}{2}$ snap roll and immediately pull through a $\frac{1}{2}$ loop, exit upright

F-15.15 Roll Combination with consecutive four rolls in opposite directions

From upright, perform consecutively four rolls in opposite directions, exit upright.

F-15.16 Pull-Pull-Push Humpty-Bump with two $\frac{1}{2}$ roll in opposite direction up, roll down

From upright, pull through a $\frac{1}{4}$ loop into a vertical upline, perform consecutively two $\frac{1}{2}$ rolls in opposite directions, pull through a $\frac{1}{2}$ loop into a vertical downline, perform a roll, push through a $\frac{1}{4}$ loop, exit inverted.

F-15.17 Stall Turn with consecutive six 1/8 rolls up, 1 3/4 snap roll down

From inverted, push through a 1/4 loop into a vertical upline, perform consecutively six 1/8 rolls, perform a stall turn into a vertical downline, perform 1 3/4 snap roll, pull through a 1/4 loop, exit upright.

For the Manoeuvre Execution Guide, see Annex 5B.

Examples of Terminology

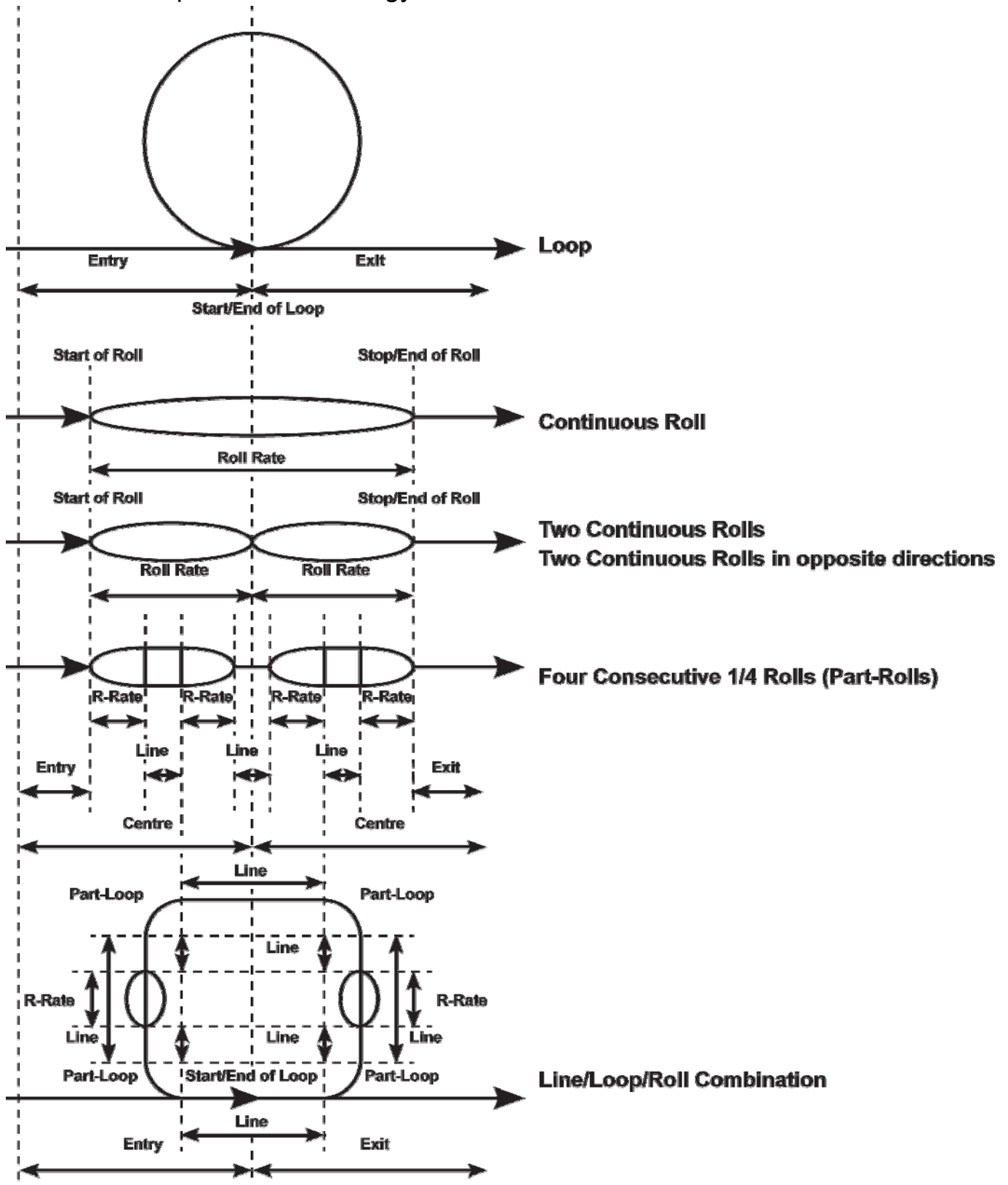

EXPLANATION OF ARESTI SYMBOLS

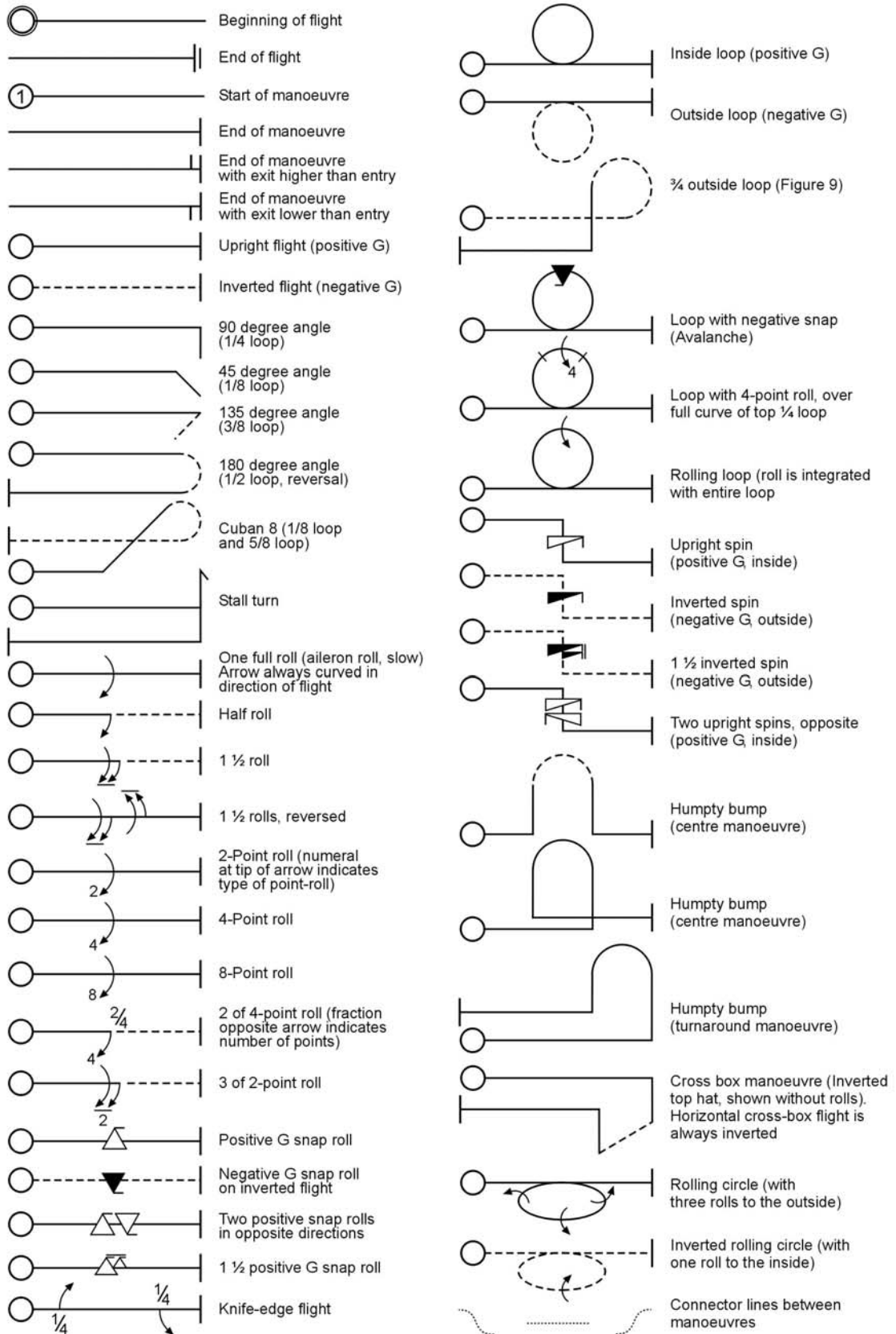

ADVANCED SCHEDULE A-14 (2013-2014)

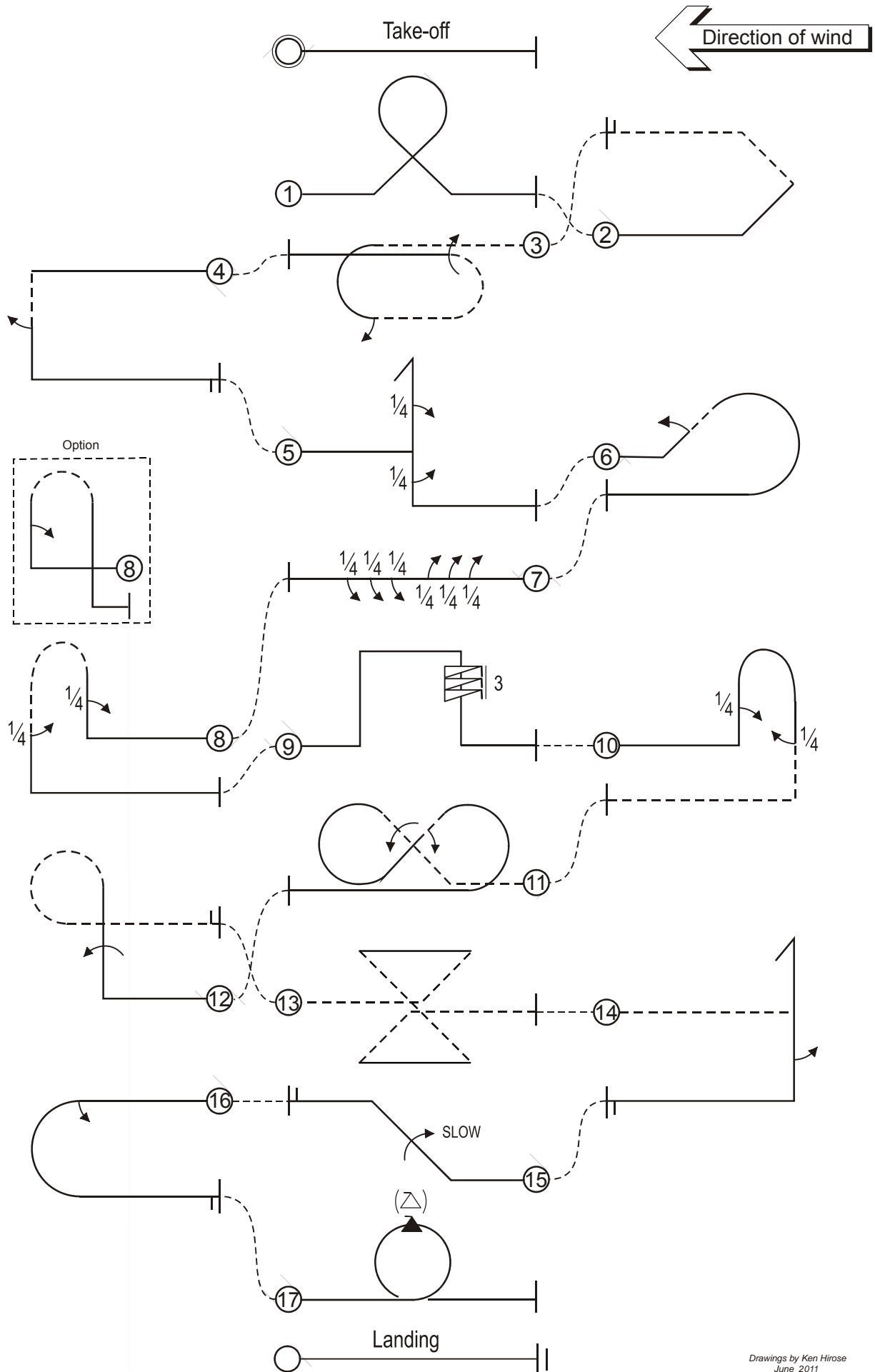

Drawings by Ken Hirose
June 2011

PRELIMINARY SCHEDULE P-13 (2012-2013)

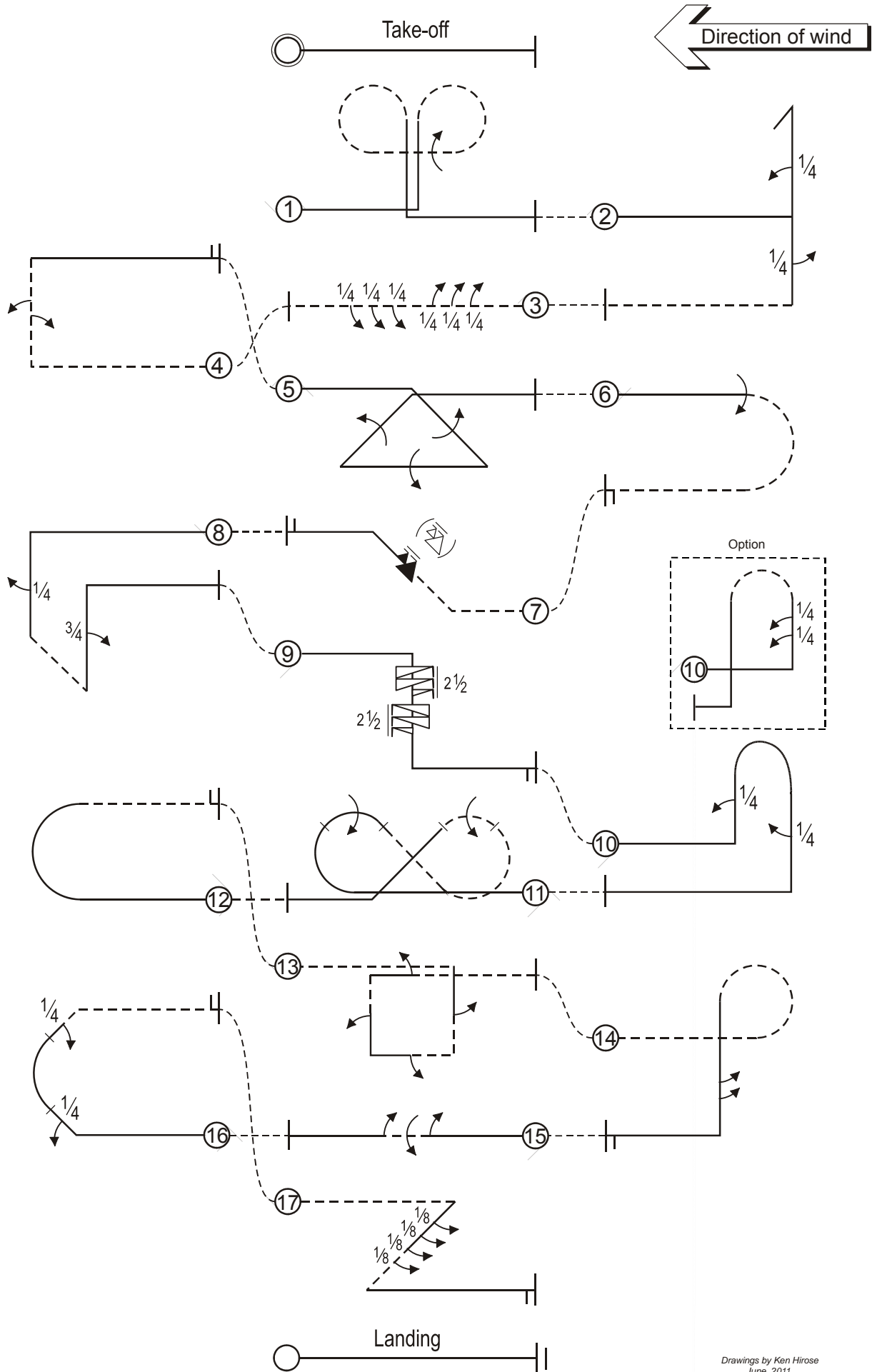

Drawings by Ken Hirose
June 2011

PRELIMINARY SCHEDULE P-15 (2014-2015)

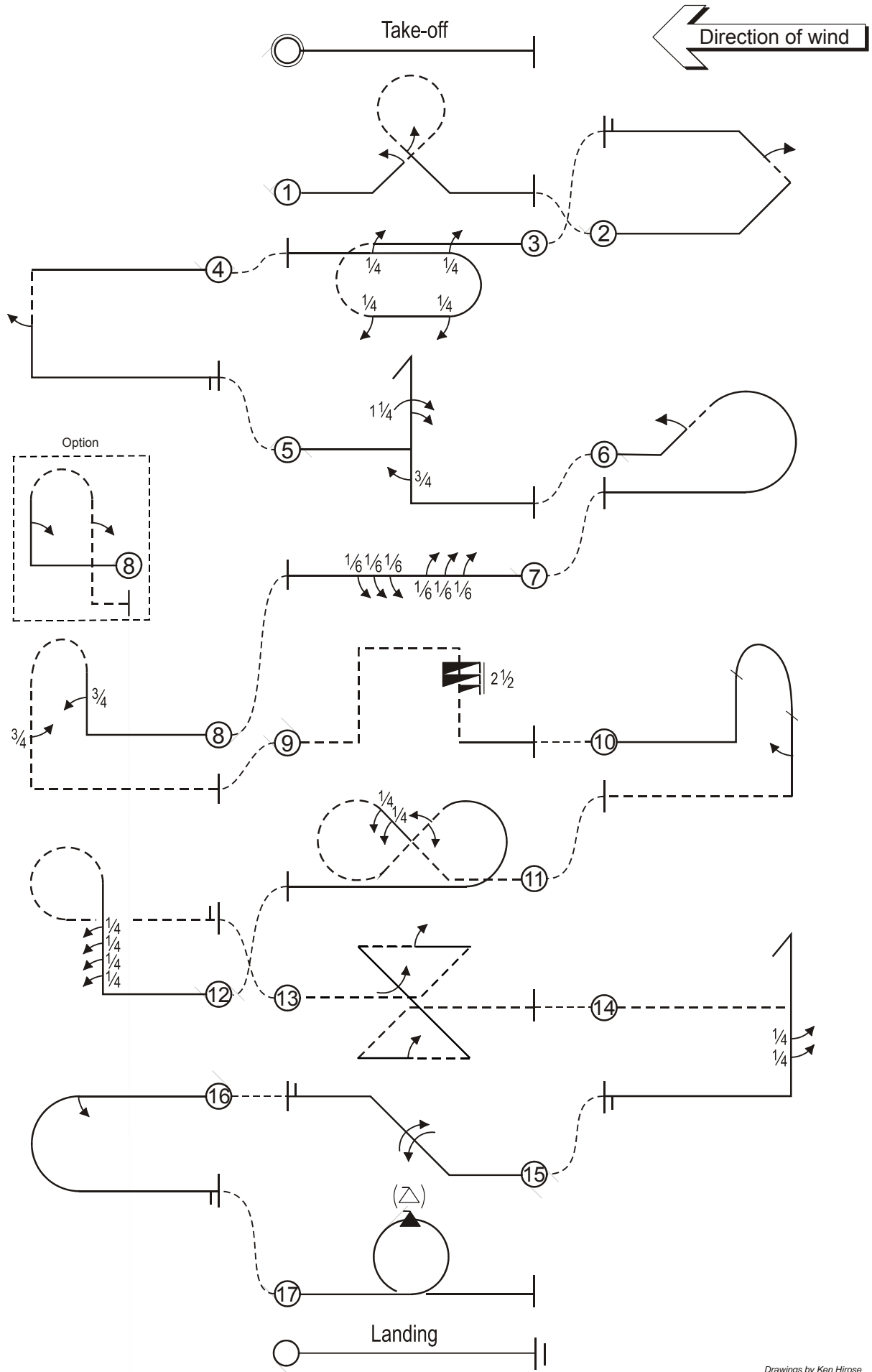

Drawings by Ken Hirose
June 2011

SEMI-FINAL AND FINAL SCHEDULE F-13 (2012-2013)

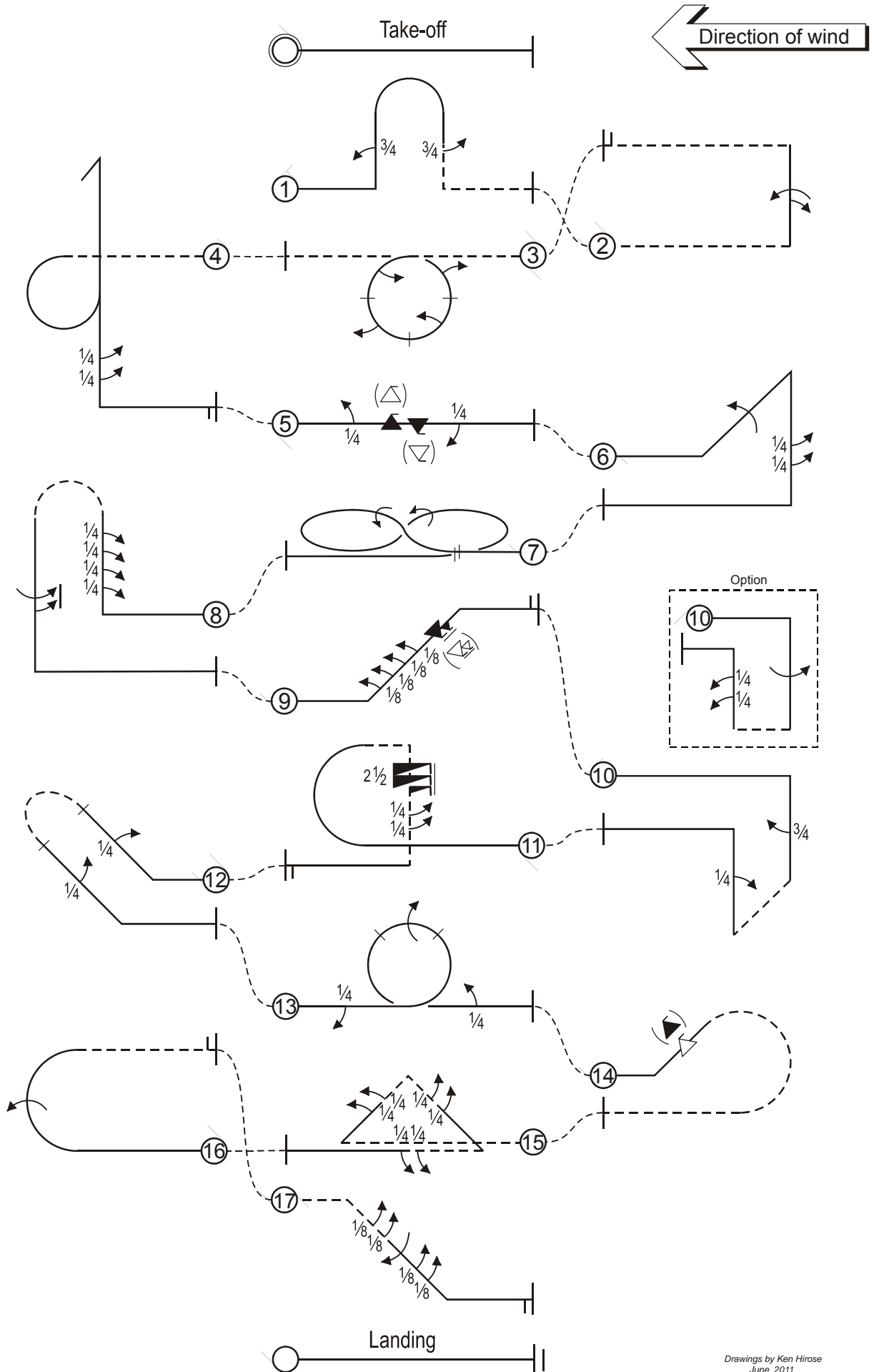

Drawings by Ken Hirose
June 2011

SEMI-FINAL AND FINAL SCHEDULE F-15 (2014-2015)

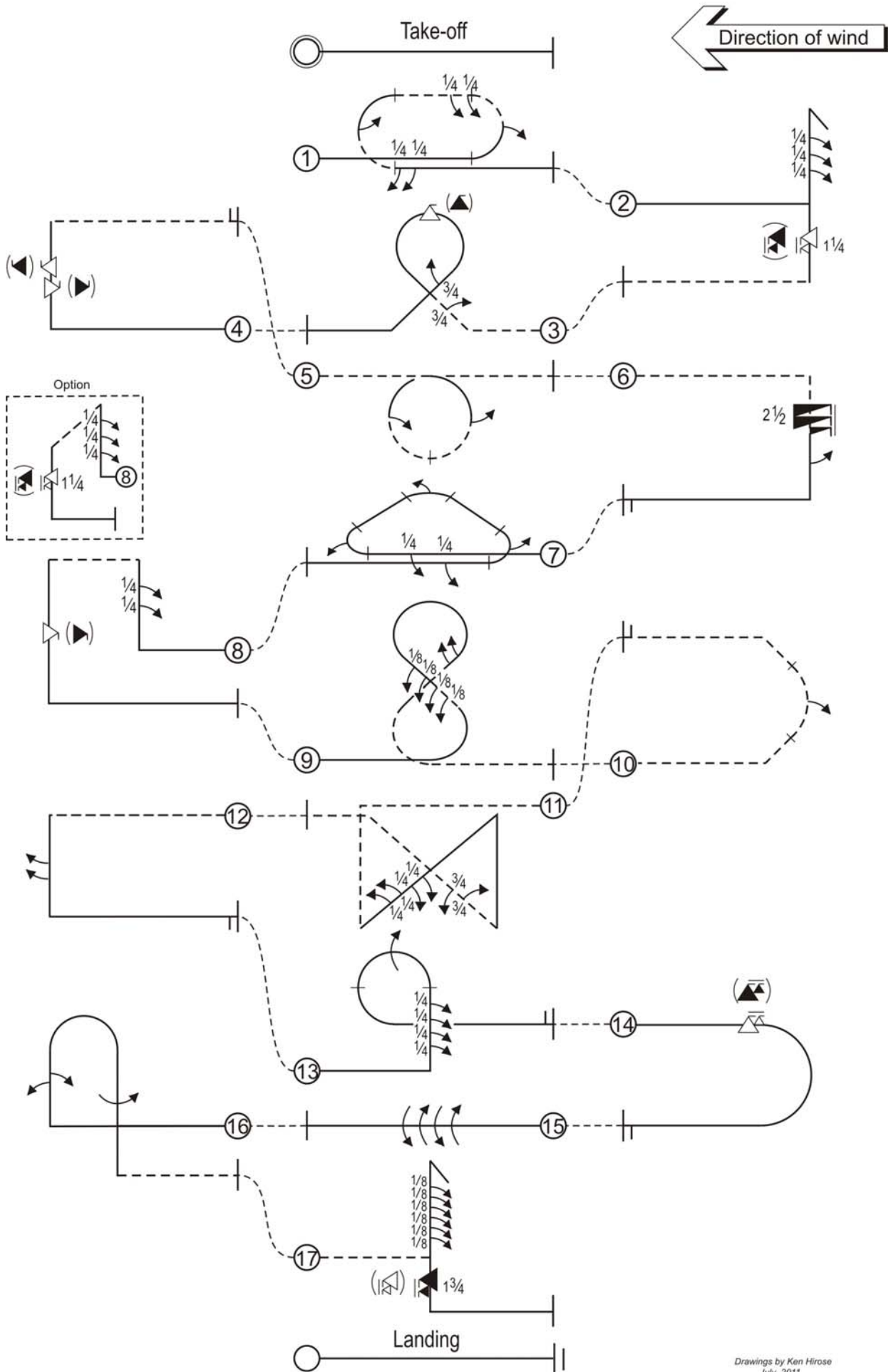

Drawings by Ken Hirose
July 2011

ANNEX 5B

F3 R/C AEROBATIC POWER MODEL AIRCRAFT

MANOEUVRE EXECUTION GUIDE

5B.1. **PURPOSE**

The purpose of the Manoeuvre Execution Guide is to give accurate guidelines for the proper execution of aerobatic manoeuvres to both judges and competitors.

Note that this guide may not be all-inclusive.

5B.2. **GENERAL**

The flight path of a model aircraft is used to judge the shape of all manoeuvres, and manoeuvres must be entered and exited with straight and level upright or inverted flight of recognisable length. Centre manoeuvres start and finish on the same heading, while turn-around manoeuvres finish on a heading 180 degrees to entry. When appropriate, entry and exit of centre manoeuvres must be at the same altitude, unless specified otherwise. Positioning adjustments in altitude are allowed in turn-around manoeuvres.

5B.3. **ACCURATE AND CONSISTENT JUDGING**

The most important aspect of consistent judging is for each judge to establish his standard and then maintain that standard throughout the competition. It is advisable for the jury president, in conjunction with the contest director and the championship organiser to hold a conference prior to the start of the competition, in order to discuss judging and make the standards as uniform as possible. This is further augmented by some practice flights which all judges score simultaneously and privately. After these flights, the defects in each manoeuvre should be discussed by all judges and agreement reached about the severity of the defects. Once the contest is started, the individual judge must not alter his standard under any influence.

An accurate standard of judging is also very important. Being a consistent judge, whether high or low, is not good if the scores awarded are not a fair reflection of the manoeuvre performed.

A judge must not, under any circumstances, favour a competitor, or a national team, or a particular flying style, or brand of equipment, or propulsion method. Judges must only look at the lines described in the sky. Conversely, acts of negative bias towards a competitor, or a national team, or a flying style, or brand of equipment, or a propulsion method, must be viewed in a serious light, and corrective action may be necessary.

The performance of the model aircraft or its propulsion device must not be allowed to influence a judge's mark.

5B.4. **PRINCIPLES**

The principles of judging the performance of a competitor in a R/C Aerobatic competition is based on the perfection with which the competitor's model aircraft executes the aerobatic manoeuvres as described in Annex 5A. The main principles used to judge the degree of perfection are:

1. Geometrical accuracy of the manoeuvre; (weighting approximately 50%).
2. Smoothness and gracefulness of the manoeuvre; (weighting approximately 25%).
3. Positioning of the manoeuvre within the manoeuvring zone; (weighting approximately 12,5%).
4. Size of the manoeuvre; (weighting approximately 12,5%).
5. Proportion of the manoeuvre outside of the manoeuvring zone (in addition to the above).

5B.5. **DOWNGRADING SYSTEM FOR JUDGING MANOEUVRES**

In Annex 5A a description of each manoeuvre is given. With reference to above principles each manoeuvre must be downgraded according to:

1. The type of defect.
2. The severity of the defect.
3. The number of times any one defect occurs, as well as the total number of defects.

Each judge gives a mark for each manoeuvre during a flight. Assuming the highest mark 10 at the start of each manoeuvre, every defect is subject to downgrade of the mark in whole numbers. A high score should remain only if no substantial, severe or multiple defects are found.

5B.6. **ATTITUDE AND FLIGHT PATH**

The flight path of a model aircraft is the trajectory of its centre of gravity. The attitude is the direction of

the fuselage centre-line in relation to the flight path.

If not otherwise stated, all judging is based on flight path.

5B.7. **WIND CORRECTION**

All manoeuvres are required to be wind corrected in such a way that the shape of the manoeuvre, as described in Annex 5A, is preserved in the model aircraft's flight path. The exceptions to this criterion are in the snap-rolls, stall turns, and spins, where the model aircraft is in a stalled condition.

5B.8. 1. **GEOMETRICAL ACCURACY OF THE MANOEUVRE**

As a guide for downgrading deviations from the defined manoeuvre geometry, the manoeuvres are divided into their different components: lines, loops, rolls, snap-rolls, horizontal circles, line/loop/roll/horizontal circle combinations, stall turns, and spins.

5B.8.2. **THE 1 POINT PER 15 DEGREE RULE**

This basic rule provides a general guide for downgrading deviations from defined manoeuvre geometry. 1 point must be subtracted for each approximate 15 degrees deviation. In general, lines must be judged more critically than deviations in yaw or roll.

5B.8.3. **LINES**

All aerobatic manoeuvres are entered and exited by a horizontal line of recognisable length. When no horizontal line is flown between two manoeuvres, the just-completed manoeuvre must be downgraded by 1 point and the upcoming manoeuvre must be downgraded by 1 point. Horizontal flying between manoeuvres which is not considered part of the exit or entry line, must be observed, but not judged for quality.

The total length of a vertical or up/downline, as dictated by the performance of the model aircraft, is not a downgrading criterion.

All lines within a manoeuvre have a start and an end which define their length. They are preceded and followed by part loops. The length of a line should only be graded when a manoeuvre contains more than one line with a given relationship to each other ie as in a square loop. If there is a minor deviation in the relationship then 1 point is subtracted, and more points are subtracted for greater deviations.

5B.8.4. **LOOPS**

A loop must have by definition, a constant radius, and must be performed in the vertical plane throughout. It is entered and exited by a well defined line which, for a complete loop, is horizontal. For a part-loop, however, such lines may be in any other plane of flight as required by the particular manoeuvre.

Loops and part-loops within one manoeuvre must have the same radius. Each occurrence of a slight difference in radius must downgrade the manoeuvre by 1 point, while more severe deviations may downgrade it by 2 or 3 points for each occurrence. The radius of the first loop or part-loop, determines the radii of subsequent loops or part-loops within one manoeuvre.

Every loop or part-loop must be performed without interruption to the circular flight path. Every visible segmentation must be downgraded by 1 point.

If the loop is not performed entirely in the vertical plane ie it drifts closer or further from the judges, minor drift must be downgraded by 1 point, while more severe drift must be downgraded by several points.

In three-, four-, six-, and eight-sided loops, The main criteria are that the loop must have the sides at the same lengths/correct angles for the defined number of times, and all part-loops must have the same radius.

5B.8.5. **ROLLS**

Rolls and part-rolls may be performed as individual manoeuvres, or as parts of other manoeuvres. The following applies to all continuous rolls and part-rolls as well as to consecutive continuous rolls and part-rolls:

- a) They must be performed on a constant flight path.
- b) The roll-rate must be constant. Small variations in roll-rate must be downgraded by 1 point, while more severe variations must receive a downgrade of 2 or more points. Slowing down (or speeding up) the roll-rate towards the end of a roll must be downgraded using the 1 point per 15 degree rule.
- c) The start and stop of the rotation must be crisp and well-defined. If a start or stop is badly defined, 1 point is subtracted for each.
- d) In all manoeuvres which have more than one continuous roll, the continuous rolls must have the same roll-rate. In all manoeuvres which have more than one part-roll, the part-rolls must have the same roll rate. Lines between consecutive part-rolls must be short and of equal length. Between consecutive

continuous rolls or part-rolls in opposite direction there must be no line. Where there are continuous rolls and part-rolls within one manoeuvre, the roll-rate for the part-rolls does not necessarily have to be the same as the roll-rate for the continuous rolls.

Particular attention has to be paid where the manoeuvre description requires continuous rolls or part-rolls to be performed in opposite directions. For a roll or part-roll performed in the wrong direction, a zero score must be given for the entire manoeuvre.

5B.8.6. **SNAP-ROLLS**

A snap-roll is a rapid auto-rotative roll where the model aircraft is in a stalled attitude, with a continuous high angle of attack.

Snap-rolls are judged in the same way as axial rolls as far as the constant flight path throughout the snap-roll, the start and stop of the rotation, and the roll direction is concerned.

At the start of a snap-roll, the fuselage attitude must show a definite stall-break and attitude separation from the flight path, before the rotation is started, since the model aircraft is supposed to be in a stalled condition throughout the snap-roll. If the stall-break does not occur and the model aircraft barrel-rolls around, the manoeuvre must be severely downgraded (more than 5 points). Similarly, axial rolls disguised as snap-rolls must be severely downgraded (more than 5 points).

Snap-rolls can be flown in both positive and negative attitudes. The attitude (positive or negative) is at the pilot's discretion. If the model aircraft returns to an unstalled condition during the snap-roll, the manoeuvre is downgraded using the 1 point per 15 degree rule.

5B.8.7. **HORIZONTAL CIRCLES**

Horizontal circles are performed in a horizontal plane and mostly used as centre manoeuvres. They may be positioned at a higher or lower altitude. Horizontal circles are mainly judged about the circular flight path, constant altitude of the circle, and by constant rates of roll, and integration of the continuous rolls or part-rolls with the circle, if applicable.

The circular flight path should be maintained throughout the manoeuvre and there must be no deviation in altitude. At low level it may be more difficult for judges to determine the roundness of the circle. The 150m distance requirement is waived for horizontal circles, and a downgrade should only be applied if the far side of the circle exceeds approximately 350m. Deviations from geometry should be downgraded as in loops and using the 1 point per 15 degree rule. Depending on the distance from the pilot at the entry, horizontal circles may be performed away from, or towards, the pilot and are at the pilot's discretion.

Other horizontal manoeuvres as combinations of horizontal circles or part-circles with lines etc have to be judged accordingly

5B.8.8. **LINE/LOOP/ROLL/HORIZONTAL CIRCLE COMBINATIONS**

These are very diversified, but all are combinations of lines, loops, part-loops, continuous rolls, part-rolls, snap-rolls, horizontal circles, and horizontal part-circles. The judging of all these components applies as described above.

Whenever a continuous roll, part-roll, snap roll, or a consecutive combination of these is placed on a line, the length of the line before and after the roll or the combination of consecutive rolls must be equal. 1 point is subtracted for a minor difference, and 2 points for a major difference. If there is a complete absence of a line before or after the roll, 3 points are subtracted.

Exceptions are all Immelman Turn and Split-S manoeuvres where rolls are always performed immediately before or after or part-loop, which means, the rolls always begin with the start of the lines and stop with the end of the lines. A visible line in-between the two components or rolls and not completely before or after the part-loop, must downgrade the manoeuvre.

Flight paths of continuous rolls or part-rolls that are integrated with loops or horizontal circles should be smooth, continuous, and of constant radius. Where an integrated roll is required, quick-rolling should be downgraded using the 1 point per 15 degree rule.

Particular attention has to be paid where the manoeuvre description requires a continuous roll or part-roll to be performed to the inside or the outside of a horizontal circle. For a continuous roll or part-roll performed in the wrong direction, a zero must be given for the manoeuvre.

5B.8.9. **STALL-TURNS**

The criteria in this manoeuvre are mainly about lines. The lines must have exactly vertical and horizontal flight paths.

The model aircraft must pivot around its centre of gravity (CG) in the yaw axis for the manoeuvre to receive a high score. If the model aircraft does not pivot on the CG, but within a radius of a half-wingspan, one point is subtracted. For a radius of pivot up to one wingspan, 2 to 3 points are subtracted and if the radius exceeds 1½ wingspans, the manoeuvre must be downgraded 4 to 5 points. A

radius of pivot of 2 wingspans or more is considered a wing-over and a zero must be given. If the model aircraft should “torque-off” during the stall turn, a downgrade must be applied using the 1 point per 15 degree rule. If the model aircraft flops forward or backward in a stall turn, a zero score must be given.

If the model aircraft shows a pendulum movement after the pivot, the manoeuvre is downgraded by 1 point. Similarly, if the model aircraft should “skid” before reaching the stall turn (early application of rudder), the manoeuvre is downgraded by 1 point. Drift of the model aircraft during the stalled condition must be ignored, provided the model aircraft does not drift outside the manoeuvring zone.

5B.8.10. **SPINS**

All spins are entered and exited with horizontal lines. In order to spin, the model aircraft must be stalled. The entry is flown in a horizontal flight path with the nose-up attitude increasing as the speed decreases. Drift of the model aircraft from the flight path at this point should not be downgraded, since it is in a near-stalled condition. However, severe yawing or weathercocking during the near-stalled condition, should be downgraded by 1 point per 15 degrees. A climbing flight path just prior to the spin must be downgraded, using the 1 point per 15 degree rule. The nose then drops as the model aircraft stalls. Simultaneously as the nose drops, the wing also drops in the direction of the spin. Drift during the rotation of the spin should not be downgraded since the model aircraft is in a stalled condition, provided the model aircraft does not drift outside the manoeuvring zone.

If the model aircraft does not stall or if the model aircraft is snap-rolled or spiral-dived into the spin, the manoeuvre is zeroed. If the model aircraft slides into the spin (is loath to spin), the manoeuvre must be downgraded by using the 1 point per 15 degree rule. Forcing the model aircraft to spin in the opposite direction as the initial rotation must be severely downgraded. Forcing the model aircraft to spin from a high angle of attack with down (or up) elevator, should be downgraded by 4 or 5 points. Judges must carefully observe the stalled attitude, which is not necessarily a complete stop, especially in no-wind conditions. This is no reason for downgrading.

After the defined number of turns, the stop of rotation is judged in the same manner as for a roll, downgraded 1 point per 15 degree deviation of heading. The spin rotation should stop parallel to the flight line. “Unloading”, or stopping the spin rotation early and then applying only aileron to roll the model aircraft to the desired attitude, should be downgraded using the 1 point per 15 degree rule.

A vertical downward line of visible length must be held after the rotation stops. The pull- or push-out is judged like a part-loop and if followed by a part-roll, should be separated by a well-defined line of straight flight. Different models spin in different attitudes, and the attitude is not to be taken into consideration, as long as the model aircraft is stalled. Any reversals in direction must be immediate, and if the model aircraft returns to an unstalled condition during the spin, the manoeuvre is severely downgraded. The rate of rotation during a reversed spin may be slightly different, without a downgrade, but if the difference is significant, 1 point is subtracted.

5B.9 **SMOOTHNESS AND GRACEFULNESS OF THE MANOEUVRE**

Concerns the harmonic appearance of an entire manoeuvre. ie maintaining a constant flight speed throughout the various manoeuvre components, like in climbing and descending sections contributes significantly to smoothness and gracefulness. Radii performed very tight or very loose, though being of equal size within one manoeuvre may be subject for downgrading Smoothness and Gracefulness.

5B.10. **POSITIONING OF THE MANOEUVRE WITHIN THE MANOEUVRING ZONE**

The entire flight must be within the manoeuvring zone to avoid being penalised.

A centre manoeuvre must be flown so that it is centred on the centre line indicated by the centre flag. If the manoeuvre is flown off-centre, it must be downgraded according to the misplacement. This may be in the range of 1 to 4 points subtracted. The centre of a centre manoeuvre is in the middle between its start and its end.

Flying so far out as to make evaluation of a manoeuvre difficult should be severely downgraded. The main criterion here is *visibility*. For a large, highly visible model aircraft, a line of flight approximately 175m in front of the pilot may be appropriate, while a smaller less visible model aircraft might have to be flown at say 140 to 150m. Manoeuvres performed on a line greater than approximately 175m in front of the pilot must be downgraded by at least 1 point.. Manoeuvres performed on a line greater than 200m in front of the pilot must be downgraded more severely (in the order of 2 to 3 points).

In general, turn-around manoeuvres are positioning manoeuvres. Therefore, entry and exit altitude need not be the same if the pilot wishes to make an altitude adjustment.

If any part of a manoeuvre is performed beyond the safety line, the manoeuvre will be zeroed. Repeated infringements of the safety line may result in the competitor being asked by the flight line director to terminate the flight, due to safety reasons.

5B.11. SIZE OF THE MANOEUVRE

The size of a manoeuvre is scored by its matching size relative to the size of the manoeuvring zone and relative to the size of the other manoeuvres performed throughout a schedule.

5B.12. PROPORTION OF THE MANOEUVRE OUTSIDE OF THE MANOEUVRING ZONE

Downgrades for flying a manoeuvre partially out of the zone should be in proportion to the degree of infraction, ie a small part of the manoeuvre (10%) flown past a 60 degree line would call for a downgrade of 1 point, while more of the manoeuvre (30%, 40%, 50% ...) flown past a 60 degree line must be downgraded accordingly by 3, 4, 5... points. If an entire manoeuvre including entry and exit is flown out of the manoeuvring zone, it consequently must be zeroed. However, violations of a 60 degree line that occur near the 150 metre line (ie approximately over a 60 degree flag) should be seen less severely than violations along a line further out and more distant from the judges.

5B.13. EXAMPLES

An avalanche is entered in a slight climb, the flight path turns 15 degrees to one side after the snap and a wing is 15 degrees low during the exit. $10 - 1 - 1 - 1 = 7$ points.

Consecutive four $\frac{1}{4}$ rolls are started late and end up slightly off-centre and there is no stop/line between the second $\frac{1}{4}$ roll and the third $\frac{1}{4}$ roll. $10 - 2 - 6$ (1 point per 15 degrees) = 2 points.

Consecutive eight $\frac{1}{8}$ rolls are started late and end up slightly off-centre, and there is no stop/line between the first $\frac{1}{8}$ roll and the second $\frac{1}{8}$ roll. $10 - 2 - 3 = 5$ points.

An Immelmann turn is not well-rounded, the half roll is started before the model aircraft reaches the top of the loop, with the wing 15 degrees low and the flight path of the model aircraft 20 degrees off heading. $10 - 1 - 2 - 1 - 2 = 4$ points.

A snap-roll on a 45 degree downline appears to be nothing more than an axial roll with a wiggle of the tail of the model aircraft. All other components are perfect. $10 - 6 = 4$ points.

During a humpty-bump, a snap roll on a vertical downline appears to be a barrel roll, and the exit radius is noticeably smaller in radius than the other two part-loops. $10 - 6 - 1 = 3$ points.

A square loop with half rolls has the first leg climbing 100 degrees. The model aircraft gallops in elevation across the top, stops the vertical downward half roll 15 degrees too early, is corrected, and the last half roll ends up 10 degrees to one side of the centre-line. $10 - 1 - 2 - 1 - 1 = 5$ points.

On a top hat with $\frac{1}{4}$ rolls, the model aircraft is accidentally rolled in the wrong direction and the horizontal flight is performed upright instead of inverted. $10 - 10 = 0$ points.

In the middle of a double Immelmann, which may be manoeuvre number 12, a competitor experiences an engine cut and the manoeuvre is not completed. $10 - 10 = 0$ points. The rest of the manoeuvres are also awarded zero points.

An otherwise flawless two-turn spin is about 45 degrees off-centre. This must be considered as a severe misplacement. $10 - 4 = 6$ points.

During a stall turn in dead-calm conditions, the flight path of the model aircraft is exactly vertical, but the model aircraft is "skidded" 15% in the upline to ensure a turn. The model aircraft shows a pendulum movement after the stall turn, and the half roll in the downline is performed directly before the part-loop exit. $10 - 1 - 1 - 3 = 5$ points.

A loop with an integrated roll on top has the roll performed rapidly with no attempt by the pilot to integrate the roll with the top 90 degree quadrant of the loop. $10 - 6 = 4$ points.

A half reverse Cuban eight is started too late, and the pilot squeezes the manoeuvre together by flying a 60 degree upline and making no line after the half roll. The manoeuvre still gets about halfway (50%) out of the zone. $10 - 1 - 3 - 5$ (misplacement, going out of the zone) = 1 point.

During an inverted spin entered flawlessly, the model aircraft unstalls and makes the final 90 degree of rotation as a vertical axial roll. $10 - 6 = 4$ points.

A pilot flies flawlessly consecutive eight $\frac{1}{8}$ rolls. $10 - 0 = 10$ points. You will not see too many of these in a competition but a manoeuvre should be awarded a 10 if there are no detectable flaws that would otherwise downgrade it to a 9.

A pilot performs a near-perfect split-S, and the only flaw is a very slight, barely visible low wing on exit. $10 - 0 = 10$ points. In some cases, an error may be so slight that a judge may want to consider giving a score of 10, rather than wait for the perfect manoeuvre to arrive.

A pilot performs a manoeuvre other than that stated on the score sheet. $10 - 10 = 0$ points.

After this incident, the pilot performs the rest of the manoeuvres out of sequence, and no manoeuvres correspond to the manoeuvres stated on the score sheet, in the order in which they are listed. All manoeuvres affected in this way score 0 points.

During a figure M, the model aircraft disappears from view behind a low cloud, or in the sun, which is directly in the background, so that only one stall turn is visible. Every judge scores N/O. The competitor will be awarded a reflight with the entire schedule being judged, but only the mark for the affected manoeuvre used to complete the tabulation.

During an avalanche, a judge fails to notice the snap-roll at the top of the manoeuvre. Score = N/O. The score tabulators will enter the numerical average of the other judges' scores, rounded to the nearest whole number.

After the last flying manoeuvre in a preliminary schedule, an official calls "time". The competitor lands his aircraft after expiry of the time limit. No penalty.

ANNEX 5G

F3A RADIO CONTROLLED AEROBATIC MODEL AIRCRAFT

UNKNOWN MANOEUVRE SCHEDULES FOR FINAL FLIGHTS

- 5G.1. Unknown manoeuvre schedules shall be used in two of the four final flights for World or Continental Championships and shall be composed by the finalists or by Subcommittee approved computer software.. The composition of any unknown schedule shall be completed no less than 12 hours before the commencement of finals flights for unknown schedules.
- 5G.2. If the composition of the unknown manoeuvre schedules is done by the finalists, each finalist nominates in turn an appropriate centre or turn-around manoeuvre from the approved and published list of manoeuvres. This nomination and selection of manoeuvres may be either manual or computer-aided. The order of selection will be determined following the random flight draw with the order repeating until the manoeuvre schedule is complete. The nominated and selected manoeuvres must conform to the following general criteria:
1. The entry of one manoeuvre must be matched to the exit of the previous manoeuvre, for entry altitude, entry attitude (level upright or level inverted flight), size of manoeuvres (wide as in a horizontal eight or narrow as in a stall turn) and direction of flight.
 2. No duplication of manoeuvres.
 3. No duplication of centre manoeuvres from the same manoeuvre group with the exclusion of group 23 manoeuvres.
 4. Spins are entered into the wind.
 5. Three manoeuvres of each schedule must have $K = 6$.
 6. Four manoeuvres of each schedule must have $K = 5$.
 7. 17 manoeuvres per unknown schedule:
 - a) 9 centre manoeuvres (5 upwind, 4 downwind).
 - b) 8 turn-around manoeuvres (4 left and 4 right).
 8. The summary of K-factors must be at least 74.
- If the composition of the unknown schedules is done by computer software, then criteria 1 - 8 apply accordingly.
- 5G.3. Once an unknown schedule has been composed and checked for correctness it must receive the final approval of the Jury and the contest director. Printed copies, showing the Aresti pictograms and manoeuvre lists, shall then be distributed to team managers, finalists, judges, jury members, and non-finalists who are scheduled to perform warm-up flights. A sufficient number shall be made available by the organisers for spectators.
- 5G.4. The judges shall receive instructions after the composition of the unknown schedule covering the unknown manoeuvres to ensure that they are fully aware of the sequence of manoeuvres.
- 5G.5. Aresti drawings of the unknown schedules must be provided to finalists and judges.
- 5G.6. Finalists may not attempt practice flights of an unknown schedule between its composition and the finals flights either with a model aircraft or via electronic flight simulator. Evidence of such practice shall be deemed cheating and shall lead to disqualification from the championships. Hand-held stick models are permitted.
- 5G.7. In addition to the warm-up flight for the finals known schedule, at least two warm-up flights must be arranged for the unknown schedule. The unknown warm-up flights may be observed by the finalists and must be judged. Under no circumstances should the flight scores of any warm-up flights be tabulated.
- 5G.8. List of manoeuvres for composition of unknown schedules
- 5G.8.1. **Centre manoeuvres**
- (Only one manoeuvre from each number group per schedule)
- 1.1 Rolling loop with one roll (from bottom) (K5)
 - 1.2 Rolling loop with one roll (from bottom) inverted entry (K5)
 - 1.3 Loop with 8-point roll (from bottom) (K5)
 - 1.4 Loop with 8-point roll (from bottom) inverted entry (K5)
 - 1.5 Loop with 4-point roll (from bottom) (K5)

cont/...

- 1.6 Loop with 4-point roll (from bottom) inverted entry (K5)
- 1.7 Knife-edge loop (K6)
- 1.8 Knife-edge loop, inverted entry and exit (K6)
- 1.9 Knife-edge loop from top (K6)
- 1.10 Knife-edge loop from top, inverted entry and exit (K6)
- 1.11 Knife-edge loop with snap roll on top (K6)
- 1.12 Knife-edge loop with snap roll on top, inverted entry and exit (K6)
- 2.1 Two loops with half rolls at top (from bottom) (K3)
- 2.2 Two loops with half rolls at top (from bottom) inverted entry (K4)
- 2.3 Two loops with half rolls at bottom (from top) (K4)
- 2.4 Two loops with half rolls at bottom (from top) inverted entry (K3)
- 2.5 Two loops with full roll first top, half roll second (from bottom) (K4)
- 2.6 Two loops with full roll first top, half roll second, inverted entry (from bottom) (K4)
- 2.7 Two loops with half roll first top, full roll second (from bottom) (K4)
- 2.8 Two loops with half roll first top, full roll second, inverted entry (from bottom) (K4)
- 2.9 Two loops with full roll first bottom, half roll second (from top) (K4)
- 2.10 Two loops with full roll first bottom, half roll second (from top) inverted entry (K4)
- 2.11 Two loops with half roll first bottom, full roll second (from top) (K4)
- 2.12 Two loops with half roll first bottom, full roll second (from top) inverted entry (K4)
- 3.1 Avalanche with full snap (from bottom) (K3)
- 3.2 Avalanche with full snap (from bottom) inverted entry (K3)
- 3.3 Avalanche with 1½ snap (from bottom) (K4)
- 3.4 Avalanche with 1½ snap, inverted entry (from bottom) (K4)
- 3.5 Avalanche with 1 negative snap (from top) (K4)
- 3.6 Avalanche with 1 positive snap (from top) inverted entry (K3)
- 4.1 Triangular loop with full roll (from bottom) (K4)
- 4.2 Triangular loop with full roll (from bottom) inverted entry (K4)
- 4.3 Triangular loop with 2/2pt roll (from bottom) (K4)
- 4.4 Triangular loop with 2/2pt roll (from bottom) inverted entry (K4)
- 4.5 Triangular loop with 2/4pt roll (from bottom) (K4)
- 4.6 Triangular loop with 2/4pt roll (from bottom) inverted entry (K4)
- 4.7 Triangular loop with snap roll (from bottom) (K4)
- 4.8 Triangular loop with snap roll (from bottom) inverted entry (K4)
- 4.9 Triangular loop with 1½ snap roll (from bottom) (K4)
- 4.10 Triangular loop with 1½ snap roll (from bottom) inverted entry (K4)
- 4.11 Triangular loop with 1/2 rolls (from bottom) (K3)
- 4.12 Triangular loop with 1/2 rolls (from bottom) inverted entry (K3)
- 4.13 Triangular loop (base at bottom) with half rolls in 45 degree legs (K3)
- 4.14 Triangular loop (base at bottom) with half rolls in 45 degree legs, inverted entry (K3)
- 4.15 Triangular loop (base at bottom) with 2/4pt rolls in 45 degree legs (K4)
- 4.16 Triangular loop (base at bottom) with 2/4pt rolls in 45 degree legs, inverted entry (K4)
- 4.17 Triangular loop (base at bottom) with 2/2pt rolls in 45 degree legs (K4)
- 4.18 Triangular loop (base at bottom) with 2/2pt rolls in 45 degree legs, inverted entry (K4)
- 4.19 Triangular loop from top (base at top) with half rolls in 45 degree legs (K4)
- 4.20 Triangular loop from top (base at top) with half rolls in 45 degree legs, inverted entry (K4)
- 4.21 Triangular loop from top (base at top) with 2/4pt rolls in 45 degree legs (K4)
- 4.22 Triangular loop from top (base at top) with 2/4pt rolls in 45 degree legs, inverted entry (K4)
- 4.23 Triangular loop from top (base at bottom) with half rolls in 45 degree legs (K4)
- 4.24 Triangular loop from top (base at bottom) with half rolls in 45 degree legs, inverted entry (K4)
- 4.25 Triangular loop from top (base at bottom) with 2/4pt rolls in 45 degree legs (K4)
- 4.26 Triangular loop from top (base at bottom) with 2/4pt rolls in 45 legs, inverted entry (K4)
- 4.27 Triangular loop from top (base at bottom) with 2/4pt roll at bottom (K4)
- 4.28 Triangular loop from top (base at bottom) with 2/4pt roll at bottom, inverted entry (K4)
- 4.29 Triangular loop from top (base at bottom) with full roll (K4)
- 4.30 Triangular loop from top (base at bottom) with full roll, inverted entry (K4)
- 4.31 Knife-edge triangular loop (base at top) (K6)
- 4.32 Knife-edge triangular loop (base at top), inverted entry and exit (K6)
- 4.33 Knife-edge triangular loop (base at top), snap roll on horizontal leg (K6)
- 4.34 Knife-edge triangular loop (base at top), snap roll on horizontal leg, inverted entry and exit (K6)
- 4.35 Knife-edge triangular loop (base at top), roll on horizontal leg (K6)
- 4.36 Knife-edge triangular loop (base at top), roll on horizontal leg, inverted entry and exit (K6)
- 5.1 Square loop with half rolls (K5)
- 5.2 Square loop with half rolls, inverted entry (K5)
- 5.3 Square loop with 2/4pt rolls (K5)

cont/...

- 5.4 Square loop with 2/4pt rolls, inverted entry (K5)
- 5.5 Square loop with full snap over top (K4)
- 5.6 Square loop with full snap over top, inverted entry (K4)
- 5.7 Square loop from top with half rolls (K5)
- 5.8 Square loop from top with half rolls, inverted entry (K5)
- 5.9 Square loop from top with 2/4pt rolls (K5)
- 5.10 Square loop from top with 2/4pt rolls, inverted entry (K5)
- 5.11 Square loop from top with full snap at bottom (K4)
- 5.12 Square loop from top with full snap at bottom, inverted entry (K4)
- 6.1 Square loop on corner (K3)
- 6.2 Square loop on corner, inverted entry (K3)
- 6.3 Square loop on corner with half rolls in legs 1 & 3 (K4)
- 6.4 Square loop on corner with half rolls in legs 1 & 3, inverted entry (K4)
- 6.5 Square loop on corner with full roll in leg 1, half roll in leg 3 (K4)
- 6.6 Square loop on corner with full roll in leg 1, half roll in leg 3, inverted entry (K4)
- 6.7 Square loop on corner with four half rolls (K5)
- 6.8 Square loop on corner with four half rolls, inverted entry (K5)
- 6.9 Square loop on corner from top (K3)
- 6.10 Square loop on corner from top, inverted entry (K3)
- 6.11 Square loop on corner from top with half rolls in legs 1 & 3 (K4)
- 6.12 Square loop on corner from top with half rolls in legs 1 & 3, inverted entry (K4)
- 6.13 Square loop on corner from top with full roll in leg 1, half roll in leg 3 (K4)
- 6.14 Square loop on corner from top with full roll in leg 1, half roll in leg 3, inverted entry (K4)
- 6.15 Square loop on corner from top with four half rolls (K5)
- 6.16 Square loop on corner from top with four half rolls, inverted entry (K5)
- 7.1 Six sided loop (K4)
- 7.2 Six sided loop, inverted entry (K4)
- 7.3 Six sided loop from top (K4)
- 7.4 Six sided loop from top, inverted entry (K4)
- 8.1 Cobra roll with 2/4pt rolls (K3)
- 8.2 Cobra roll with 2/4pt rolls, inverted entry (K3)
- 8.3 Cobra roll with 2/2pt rolls (K3)
- 8.4 Cobra roll with 2/2pt rolls, inverted entry (K3)
- 8.5 Cobra roll from top with half rolls (K3)
- 8.6 Cobra roll from top with half rolls, inverted entry (K3)
- 8.7 Cobra roll from top with 2/4pt rolls (K3)
- 8.8 Cobra roll from top with 2/4pt rolls, inverted entry (K3)
- 8.9 Cobra roll from top with 2/2pt rolls (K3)
- 8.10 Cobra roll from top with 2/2pt rolls, inverted entry (K3)
- 9.1 Golf ball (45 degrees up, 3/4 inside loop, 45 degrees down, pull to level), (K3)
- 9.2 Golf ball, inverted entry (K3)
- 9.3 Golf ball with half rolls (K3)
- 9.4 Golf ball with half rolls, inverted entry (K3)
- 9.5 Golf ball with 2/4pt rolls (K3)
- 9.6 Golf ball with 2/4pt rolls, inverted entry (K3)
- 10.1 Cuban eight with 2/4pt rolls (K3)
- 10.2 Cuban eight with 2/4pt rolls, inverted entry (K3)
- 10.3 Cuban eight with full rolls (K4)
- 10.4 Cuban eight with full rolls, inverted entry (K4)
- 10.5 Reverse cuban eight (from bottom) with 2/4pt rolls (K4)
- 10.6 Reverse cuban eight (from bottom) with 2/4pt rolls, inverted entry (K4)
- 10.7 Reverse cuban eight (from bottom) with full rolls (K4)
- 10.8 Reverse cuban eight (from bottom) with full rolls, inverted entry (K4)
- 10.9 Cuban eight from top with half rolls (K3)
- 10.10 Cuban eight from top with half rolls, inverted entry (K3)
- 10.11 Cuban eight from top with 2/4pt rolls (K4)
- 10.12 Cuban eight from top with 2/4pt rolls, inverted entry (K4)
- 10.13 Cuban eight from top with full rolls (K4)
- 10.14 Cuban eight from top with full rolls, inverted entry (K4)
- 10.15 Reverse cuban eight from top with half rolls (K3)
- 10.16 Reverse cuban eight from top with half rolls, inverted entry (K3)
- 10.17 Reverse cuban eight from top with 2/4pt rolls (K4)
- 10.18 Reverse cuban eight from top with 2/4pt rolls, inverted entry (K4)
- 10.19 Reverse cuban eight from top with full rolls (K4)

cont/...

- 10.20 Reverse cuban eight from top with full rolls, inverted entry (K4)
- 10.21 Knife-edge Cuban eight (K6)
- 10.22 Knife-edge Cuban eight, inverted entry and exit (K6)
- 10.23 Knife-edge Cuban eight with full rolls (K6)
- 10.24 Knife-edge Cuban eight with full rolls, inverted entry and exit (K6)
- 10.25 Knife-edge reverse Cuban eight (K6)
- 10.26 Knife-edge reverse Cuban eight, inverted entry and exit (K6)
- 10.27 Knife-edge reverse Cuban eight with full rolls (K6)
- 10.28 Knife-edge reverse Cuban eight with full rolls, inverted entry and exit (K6)
- 11.1 45 degree down with full snap roll (K3)
- 11.2 45 degree down with full snap roll, inverted entry (K3)
- 11.3 45 degree down with 1½ snap roll (K3)
- 11.4 45 degree down with 1½ snap roll, inverted entry (K3)
- 11.5 45 degree down with two 2/4-point rolls reversed (K4)
- 11.6 45 degree down with two 2/4-point rolls reversed, inverted entry (K4)
- 11.7 45 degree down with two 4/8-point rolls reversed (K4)
- 11.8 45 degree down with two 4/8-point rolls reversed, inverted entry (K4)
- 11.9 45 degree up with 1½ snap roll (K4)
- 11.10 45 degree up with 1½ snap roll, inverted entry (K4)
- 11.11 45 degree up with full snap roll (K3)
- 11.12 45 degree up with full snap roll, inverted entry (K3)
- 11.13 45 degree up with two 2/4-point rolls reversed (K4)
- 11.14 45 degree up with two 2/4-point rolls reversed, inverted entry (K4)
- 11.15 45 degree up with two 4/8-point rolls reversed (K4)
- 11.16 45 degree up with two 4/8-point rolls reversed, inverted entry (K4)
- 12.1 Figure Z with half roll up (K3)
- 12.2 Figure Z with half roll up, inverted entry (K3)
- 12.3 Figure Z with 2/4pt roll up (K4)
- 12.4 Figure Z with 2/4pt roll up, inverted entry (K4)
- 12.5 Figure Z with 2/2pt roll up (K4)
- 12.6 Figure Z with 2/2pt roll up, inverted entry (K4)
- 12.7 Figure Z from top with half roll down (K3)
- 12.8 Figure Z from top with half roll down, inverted entry (K3)
- 12.9 Figure Z from top with 2/4pt roll down (K4)
- 12.10 Figure Z from top with 2/4pt roll down, inverted entry (K4)
- 12.11 Figure Z from top with 2/2pt roll (K4)
- 12.12 Figure Z from top with 2/2pt roll, inverted entry (K4)
- 13.1 Hourglass (K4)
- 13.2 Hourglass, inverted entry (K4)
- 13.3 Hourglass with half rolls up and down (K4)
- 13.4 Hourglass with half rolls up and down, inverted entry (K5)
- 13.5 Hourglass with 2/4pt rolls up and down (K5)
- 13.6 Hourglass with 2/4pt rolls up and down, inverted entry (K5)
- 13.7 Hourglass (middle entry, top first) (K4)
- 13.8 Hourglass (middle entry, top first) inverted entry (K4)
- 13.9 Hourglass (middle entry, top first), half roll down (K4_
- 13.10 Hourglass (middle entry, top first) half roll down, inverted entry (K4)
- 13.11 Hourglass (middle entry, top first) 2/4pt roll down (K5)
- 13.12 Hourglass (middle entry, top first) 2/4pt roll down, inverted entry (K5)
- 13.13 Hourglass (middle entry, bottom first) (K4)
- 13.14 Hourglass (middle entry, bottom first), inverted entry (K4)
- 13.15 Hourglass (middle entry, bottom first) half roll up (K4)
- 13.16 Hourglass (middle entry, bottom first) half roll up, inverted entry (K4)
- 13.17 Hourglass (middle entry, bottom first) 2/4pt roll up (K4)
- 13.18 Hourglass (middle entry, bottom first) 2/4pt roll up, inverted entry (K4)
- 13.19 Hourglass (top entry) (K4)
- 13.20 Hourglass (top entry), inverted entry (K4)
- 13.21 Hourglass (top entry) with half rolls down and up (K5)
- 13.22 Hourglass (top entry) with half rolls down and up, inverted entry (K5)
- 13.23 Hourglass (top entry) with 2/4pt rolls down and up (K5)
- 13.24 Hourglass (top entry) with 2/4pt rolls down and up, inverted entry (K5)
- 14.1 Vertical eight (from bottom) (K3)
- 14.2 Vertical eight (from bottom) inverted entry (K3)
- 14.3 Vertical eight (from bottom) with half rolls (K4)

cont/...

- 14.4 Vertical eight (from bottom) with half rolls, inverted entry (K4)
- 14.5 Vertical eight (from bottom) with half roll after first half loop (K4)
- 14.6 Vertical eight (from bottom) with half roll after first half loop, inverted entry (K4)
- 14.7 Vertical eight (from middle) (K3)
- 14.8 Vertical eight (from middle) inverted entry (K3)
- 14.9 Vertical eight (from middle) with half roll (K3)
- 14.10 Vertical eight (from middle) with half roll, inverted entry (K3)
- 14.11 Vertical eight (from top) (K3)
- 14.12 Vertical eight (from top) inverted entry (K3)
- 14.13 Vertical eight (from top) with half rolls (K4)
- 14.14 Vertical eight (from top) with half rolls, inverted entry (K4)
- 14.15 Vertical eight (from top) with half roll after first half loop (K4)
- 14.16 Vertical eight (from top) with half roll after first half loop, inverted entry (K4)
- 14.17 Vertical knife-edge eight (K6)
- 14.18 Vertical knife-edge eight, inverted entry and exit (K6)
- 14.19 Vertical knife-edge eight with two half roll (K6)
- 14.20 Vertical knife-edge eight with two half roll, inverted entry and exit (K6)
- 14.21 Vertical knife-edge eight, middle entry and exit, top first (K6)
- 14.22 Vertical knife-edge eight, middle entry and exit, top first, inverted entry & exit (K6)
- 15.1 Square horizontal eight (K5)
- 15.2 Square horizontal eight, inverted entry (K5)
- 15.3 Square horizontal eight (from top) (K5)
- 15.4 Square horizontal eight (from top) inverted entry (K5)
- 15.5 Square vertical eight (from bottom) (K5)
- 15.6 Square vertical eight (from bottom) inverted entry (K5)
- 15.7 Square vertical eight (from bottom) with half rolls (K5)
- 15.8 Square vertical eight (from bottom) with half rolls, inverted entry (K5)
- 15.9 Square vertical eight (from middle) (K5)
- 15.10 Square vertical eight (from middle) inverted entry (K5)
- 15.11 Square vertical eight (from middle) with half roll (K5)
- 15.12 Square vertical eight (from middle) with half roll, inverted entry (K5)
- 15.13 Square vertical eight (from top) (K5)
- 15.14 Square vertical eight (from top) inverted entry (K5)
- 15.15 Square vertical eight (from top) with half rolls (K5)
- 15.16 Square vertical eight (from top) with half rolls, inverted entry (K5)
- 16.1 Figure M with 3/4 rolls (K5)
- 16.2 Figure M with 3/4 rolls, inverted entry (K5)
- 16.3 Figure M with 3/4-point rolls (K5)
- 16.4 Figure M with 3/4-point rolls, inverted entry (K5)
- 16.5 Figure M with 3/4pt rolls up, 1/4 rolls down (K5)
- 16.6 Figure M with 3/4pt rolls up, 1/4 rolls down, inverted entry (K5)
Centre half-loop is always flown negative (inverted)
- 17.1 Top hat with 2/4pt rolls (K4)
- 17.2 Top hat with 2/4pt rolls, inverted entry (K4)
- 17.3 Top hat with 2/2pt rolls (K4)
- 17.4 Top hat with 2/2pt rolls, inverted entry (K4)
- 17.5 Top hat from top with 2/4pt rolls (K4)
- 17.6 Top hat from top with 2/4pt rolls, inverted entry (K4)
- 17.7 Top hat from top with 2/2pt rolls (K4)
- 17.8 Top hat from top with 2/2pt rolls, inverted entry (K4)
- 18.1 Humpty bump, half roll up, 2/4pt roll down (K4)
- 18.2 Humpty bump, 1/2 roll up, 2/4pt roll down, inverted entry (K4)
- 18.3 Humpty bump, 2/4pt roll up, full snap down (K5)
- 18.4 Humpty bump, 2/4pt roll up, full snap down, inverted entry (K5)
- 18.5 Humpty bump from top, half roll down, 2/4pt roll up (K4)
- 18.6 Humpty bump from top, half roll down, 2/4pt roll up, inverted entry (K4)
- 18.7 Humpty bump from top, 2/4pt roll down, full roll up (K4)
- 18.8 Humpty bump from top, 2/4pt roll down, full roll up, inverted entry (K4)
- 19.1 2½ turn spin, inverted exit (K3)
- 19.2 2½ turn spin, inverted entry, upright exit (K3)
- 19.3 2 turn opposite spin (K4)
- 19.4 Two turn opposite spin, inverted entry (K4)
- 19.5 Three turn spin (K3)
- 19.6 Three turn spin, inverted entry (K3)

cont/...

- 19.7 2½ turn spin, half roll exit (K3)
- 19.8 2½ turn spin, half roll exit, inverted entry (K3)
- 20.1 Stall turn 3/4 roll up, 3/4pt roll down (K3)
- 20.2 Stall turn, 3/4 roll up, 3/4pt roll down, inverted entry (K3)
- 20.3 Stall turn 3/4 roll up, 3/4-point roll down, inverted exit (K3)
- 20.4 Stall turn, 3/4 roll up, 1¼ snap roll down (K5)
- 20.5 Stall turn, 3/4 roll up, 1¼ snap roll down, inverted entry (K5)
- 20.6 Stall turn, 3/4 roll up, 1¼ snap roll down, inverted exit (K5)
- 20.7 Stall turn, 3/4pt roll up, 1¼ snap roll down (K5)
- 20.8 Stall turn, 3/4pt roll up, 1¼ snap roll down, inverted entry (K5)
- 20.9 Stall turn, 3/4pt roll up, 1¼ snap roll down, inverted exit (K5)
- 21.1 Double Immelmann with half rolls (K3)
- 21.2 Double Immelmann with half rolls, inverted entry (K3)
- 21.3 Double Immelmann with half roll first, full roll second (K4)
- 21.4 Double Immelmann with half roll first, full roll second, inverted entry (K4)
- 21.5 Double Immelmann with full rolls (K3)
- 21.6 Double Immelmann with full rolls, inverted entry (K3)
- 21.7 Double Immelmann from top, half rolls (K3)
- 21.8 Double Immelmann from top, half rolls, inverted entry (K3)
- 21.9 Double Immelmann from top, half roll first, full roll second (K4)
- 21.10 Double Immelmann from top, half roll first, full roll second, inverted entry (K4)
- 21.11 Double Immelmann from top with full rolls (K4)
- 21.12 Double Immelmann from top with full rolls, inverted entry (K4)
- 22.1 Rolling circle with one roll inside (K5)
- 22.2 Rolling circle with one roll inside, inverted entry (K5)
- 22.3 Rolling circle with one roll outside (K5)
- 22.4 Rolling circle with one roll outside, inverted entry (K5)
- 22.5 Rolling circle with 2 rolls inside (K5)
- 22.6 Rolling circle with 2 rolls inside, inverted entry (K5)
- 22.7 Rolling circle with 2 rolls outside (K5)
- 22.8 Rolling circle with 2 rolls outside, inverted entry (K5)
- 22.9 Rolling circle with 4 rolls inside (K5)
- 22.10 Rolling circle with 4 rolls inside, inverted entry (K5)
- 22.11 Rolling circle with 4 rolls outside (K5)
- 22.12 Rolling circle with 4 rolls outside, inverted entry (K5)

(More than one manoeuvre from the following group is allowed, but not two of the same manoeuvre with only the entry changed)

- 23.1 1½ rolls reversed (K4)
- 23.2 1½ rolls reversed, inverted entry (K4)
- 23.3 Two rolls reversed (K4)
- 23.4 Two rolls reversed, inverted entry (K4)
- 23.5 Four point roll (K4)
- 23.6 Four point roll, inverted entry (K4)
- 23.7 Eight point roll (K4)
- 23.8 Eight point roll, inverted entry (K4)
- 23.9 Two 3/4-point rolls reversed (K4)
- 23.10 Two 3/4-point rolls reversed, inverted entry (K4)
- 23.11 Two 2/2-point rolls reversed (K4)
- 23.12 Two 2/2-point rolls reversed, inverted entry (K4)
- 23.13 Two 2/4-point rolls reversed (K4)
- 23.14 Two 2/4-point rolls reversed, inverted entry (K4)
- 23.15 Slow roll (K3)
- 23.16 Slow roll, inverted entry (K3)
- 23.17 Knife-edge flight (K4)
- 23.18 Knife-edge flight, inverted entry (K4)
- 23.19 Reverse knife-edge flight (K5)
- 23.20 Reverse knife-edge flight, inverted entry (K5)
- 23.21 One horizontal snap roll (K3)
- 23.22 One horizontal snap roll, inverted entry (K4)
- 23.23 Two snap rolls reversed (K5)
- 23.24 Two snap rolls reversed, inverted entry (K5)
- 23.25 2/2pt roll, full snap roll opposite (K5)
- 23.26 2/2pt roll, full snap roll opposite, inverted entry (K5)

cont/...

- 23.27 2/4pt roll, 1½ snap roll opposite (K5)
- 23.28 2/4pt roll, 1½ snap roll opposite, inverted entry (K5)
- 24.1 Double key: pull into vertical upline, ¾-point roll up, 5/8 knife-edge loop towards the back, ¾ roll down, pull into 45°upline, ¾.roll up, 5/8 knife-edge loop towards the back, ¾-point roll down, pull to exit upright (K6)
- 24.2 Double key: from inverted push into vertical upline, ¾-point roll up, 5/8 knife-edge loop towards the back, ¾ roll down, pull into 45° upline, ¾ roll, 5/8 knife-edge loop towards the back, ¾-point roll down, push to exit inverted (K6)
- 24.3 Double key: pull into a vertical upline, ¾-point roll up, 5/8 knife-edge loop towards the back, ¾ roll down, push into a 45° upline, ¾ roll up, 5/8 knife-edge loop towards the back, ¾-point roll down, pull to exit upright (K6)
- 24.4 Double key: from inverted push into vertical upline, ¾-point roll up, 5/8 knife-edge loop towards the back, ¾ roll down, push into 45° upline, ¾ roll up, 5/8 knife-edge loop towards the back, ¾-point roll down, push to exit inverted (K6)
- 25.1 Horizontal eight with one roll integrated in each loop (K6)
- 25.2 Horizontal eight with one roll integrated in each loop, inverted entry and exit (K6)
- 25.3 Horizontal eight with two rolls integrated in each loop (K6)
- 25.4 Horizontal eight with two rolls integrated in each loop, inverted entry and exit (K6)
- 25.5 Horizontal eight with four rolls integrated in each loop (K6)
- 25.6 Horizontal eight with four rolls integrated in each loop, inverted entry and exit (K6)

5G.8.2. Turnaround manoeuvres

(maximum of two manoeuvres from each group per schedule)

- A.1 Half square loop (K1)
- A.2 Half square loop, inverted entry (K1)
- A.3 Half square loop with half roll up (K2)
- A.4 Half square loop with half roll up, inverted entry (K2)
- A.5 Half square loop with 2/4pt roll up (K2)
- A.6 Half square loop with 2/4pt roll up, inverted entry (K2)
- A.7 Half square loop with 2/2pt roll up (K2)
- A.8 Half square loop with 2/2pt roll up, inverted entry (K2)
- A.9 Half square loop with full roll up (K2)
- A.10 Half square loop with full roll up, inverted entry (K2)
- A.11 Half square loop from top (K1)
- A.12 Half square loop from top, inverted entry (K1)
- A.13 Half square loop from top, half roll down (K2)
- A.14 Half square loop from top, half roll down, inverted entry (K2)
- A.15 Half square loop from top, 2/4pt roll down (K2)
- A.16 Half square loop from top, 2/4pt roll down, inverted entry (K2)
- A.17 Half square loop from top, 2/2pt roll down (K2)
- A.18 Half square loop from top, 2/2pt roll down, inverted entry (K2)
- A.19 Half square loop from top, full roll down (K2)
- A.20 Half square loop from top, full roll down, inverted entry (K2)
- A.21 Half square loop from top, full snap down (K3)
- A.22 Half square loop from top, full snap down, inverted entry (K3)
- B.1 Half loop (K1)
- B.2 Half outside loop, inverted entry (K1)
- B.3 Half outside loop from top (K1)
- B.4 Half loop from top, inverted entry (K1)
- C.1 Split "S" (half roll, half loop from top) (K2)
- C.2 Half inside loop, half roll, from top, inverted entry (K2)
- C.3 Half outside loop, full roll, from top (K2)
- C.4 Half inside loop, full roll, from top, inverted entry (K2)
- D.1 Immelmann turn (K2)
- D.2 Immelmann turn, inverted entry (K2)
- D.3 Immelmann turn, full roll (K2)
- D.4 Immelmann turn, full roll, inverted entry (K2)
- E.1 Figure 9 from bottom (K1)
- E.2 Figure 9 from bottom, inverted entry (K1)
- E.3 Figure 9 from bottom, half roll up (K2)
- E.4 Figure 9 from bottom, half roll up, inverted entry (K2)
- E.5 Figure 9 from bottom, 2/4pt roll up (K2)
- E.6 Figure 9 from bottom, 2/4pt roll up, inverted entry (K2)

cont/...

- E.7 Figure 9 from bottom, 2/2pt roll up (K2)
- E.8 Figure 9 from bottom, 2/2pt roll up, inverted entry (K2)
- E.9 Figure 9 from bottom, full roll up (K2)
- E.10 Figure 9 from bottom, full roll up, inverted entry (K2)
- E.11 Figure 6 from middle (bottom first) (K1)
- E.12 Figure 6 from middle (bottom first), inverted entry (K1)
- E.13 Figure 6 from middle (bottom first), half roll up (K2)
- E.14 Figure 6 from middle (bottom first), half roll up, inverted entry (K2)
- E.15 Figure 6 from middle (bottom first), 2/4pt roll up (K2)
- E.16 Figure 6 from middle (bottom first), 2/4pt roll up, inverted entry (K2)
- E.17 Figure 6 from middle (bottom first), 2/2pt roll up (K2)
- E.18 Figure 6 from middle (bottom first), 2/2pt roll up, inverted entry (K2)
- E.19 Figure 6 from middle (bottom first), full roll up (K2)
- E.20 Figure 6 from middle (bottom first), full roll up, inverted entry (K2)
- E.21 Figure 9 from middle (top first) (K1)
- E.22 Figure 9 from middle (top first), inverted entry (K1)
- E.23 Figure 9 from middle (top first), half roll down (K2)
- E.24 Figure 9 from middle (top first), half roll down, inverted entry (K2)
- E.25 Figure 9 from middle (top first), 2/4pt roll down (K2)
- E.26 Figure 9 from middle (top first), 2/4pt roll down, inverted entry (K2)
- E.27 Figure 9 from middle (top first), 2/2pt roll down (K2)
- E.28 Figure 9 from middle (top first), 2/2pt roll down, inverted entry (K2)
- E.29 Figure 9 from middle (top first), full roll down (K2)
- E.30 Figure 9 from middle (top first), full roll down, inverted entry (K2)
- E.31 Figure 9 from middle (top first), full snap down (K3)
- E.32 Figure 9 from middle (top first), full snap down, inverted entry (K3)
- E.33 Figure 6 from top (K1)
- E.34 Figure 6 from top, inverted entry (K1)
- E.35 Figure 6 from top, half roll down (K2)
- E.36 Figure 6 from top, half roll down, inverted entry (K2)
- E.37 Figure 6 from top, 2/4pt roll down (K2)
- E.38 Figure 6 from top, 2/4pt roll down, inverted entry (K2)
- E.39 Figure 6 from top, 2/2pt roll down (K2)
- E.40 Figure 6 from top, 2/2pt roll down, inverted entry (K2)
- E.41 Figure 6 from top, full roll down (K2)
- E.42 Figure 6 from top, full roll down, inverted entry (K2)
- E.43 Figure 6 from top, full snap down (K3)
- E.44 Figure 6 from top, full snap down, inverted entry (K3)
- F.1 Half cuban eight (K2)
- F.2 Half cuban eight, inverted entry (K2)
- F.3 Half cuban eight, 2/4pt roll (K2)
- F.4 Half cuban eight, 2/4pt roll, inverted entry (K2)
- F.5 Half cuban eight, 2/2pt roll (K2)
- F.6 Half cuban eight, 2/2pt roll, inverted entry (K2)
- F.7 Half cuban eight with full roll (K2)
- F.8 Half cuban eight with full roll, inverted entry (K2)
- F.9 Half cuban eight with full snap roll (K3)
- F.10 Half cuban eight with full snap roll, inverted entry (K3)
- F.11 Half cuban eight with 1½ snap roll (K3)
- F.12 Half cuban eight with 1½ snap roll, inverted entry (K3)
- F.13 Half cuban eight from top (K2)
- F.14 Half cuban eight from top, inverted entry (K2)
- F.15 Half cuban eight from top, 2/4pt roll up (K2)
- F.16 Half cuban eight from top, 2/4pt roll up, inverted entry (K2)
- F.17 Half cuban eight from top, 2/2pt roll up (K2)
- F.18 Half cuban eight from top, 2/2pt roll up, inverted entry (K2)
- F.19 Half cuban eight from top, full roll up (K2)
- F.20 Half cuban eight from top, full roll up, inverted entry (K2)
- F.21 Half reverse cuban eight (K2)
- F.22 Half reverse cuban eight, inverted entry (K2)
- F.23 Half reverse cuban eight, 2/4pt roll (K2)
- F.24 Half reverse cuban eight, 2/4pt roll, inverted entry (K2)
- F.25 Half reverse cuban eight, 2/2pt roll (K2)
- F.26 Half reverse cuban eight, 2/2pt roll, inverted entry (K2)

cont/...

- F.27 Half reverse cuban eight with full roll (K2)
 F.28 Half reverse cuban eight with full roll, inverted entry (K2)
 F.29 Half reverse cuban eight with full snap roll (K3)
 F.30 Half reverse cuban eight with full snap roll, inverted entry (K3)
 F.31 Half reverse cuban eight with 11/2 snap roll (K3)
 F.32 Half reverse cuban eight with 11/2 snap roll, inverted entry (K3)
 F.33 Half reverse cuban eight from top (K2)
 F.34 Half reverse cuban eight from top, inverted entry (K2)
 F.35 Half reverse cuban eight from top, 2/4pt roll down (K2)
 F.36 Half reverse cuban eight from top, 2/4pt roll down, inverted entry (K2)
 F.37 Half reverse cuban eight from top, 2/2pt roll down (K2)
 F.38 Half reverse cuban eight from top, 2/2pt roll down, inverted entry (K2)
 F.39 Half reverse cuban eight from top, full roll down (K2)
 F.40 Half reverse cuban eight from top, full roll down, inverted entry (K2)
 G.1 Two turn spin (K2)
 G.2 Two turn spin, inverted entry (K2)
 G.3 2 1/2 turn spin (K2)
 G.4 2 1/2 turn spin, inverted entry (K2)
 H.1 Stall turn, half rolls (K2)
 H.2 Stall turn, half rolls, inverted entry (K2)
 H.3 Stall turn, half roll up, 2/4pt roll down (K2)
 H.4 Stall turn, half roll up, 2/4pt roll down, inverted entry (K2)
 H.5 Stall turn, full roll up, half roll down (K2)
 H.6 Stall turn, full roll up, half roll down, inverted entry (K2)
 H.7 Stall turn, 2/4pt roll up, half roll down (K2)
 H.8 Stall turn, 2/4pt roll up, half roll down, inverted entry (K2)
 H.9 Stall turn, 2/2pt roll up, 2/4pt roll down (K2)
 H.10 Stall turn, 2/2pt roll up, 2/4pt roll down, inverted entry (K2)
 H.11 Stall turn, half roll up, full snap down (K4)
 H.12 Stall turn, half roll up, full snap down, inverted entry (K4)
 H.13 Stall turn, 3/4pt roll up, 1/4 roll down (K3)
 H.14 Stall turn, 3/4pt roll up, 1/4 roll down, inverted entry (K3)
 H.15 Stall turn, 3/4 roll up, 1¼ snap down (K4)
 H.16 Stall turn 3/4 roll up, 1¼ snap down, inverted entry (K4)
 J.1 Top hat, 3/4 roll up, 1/4 roll down (K2)
 J.2 Top hat, 3/4 roll up, 1/4 roll down, inverted entry (K2)
 J.3 Top hat, 3/4pt roll up, 3/4 roll down (K2)
 J.4 Top hat, 3/4pt roll up, 3/4 roll down, inverted entry (K2)
 J.5 Top hat, 3/4pt roll up, 3/4-point roll down, inverted exit (K2)
 J.6 Top hat, 3/4pt roll up, 3/4pt roll down, inverted entry and exit (K2)
 J.7 Top hat, 1/4 roll up, 1/4 roll down (K2)
 J.8 Top hat, 1/4 roll up, 1/4 roll down, inverted entry (K2)
 J.9 Top hat, 1/4 roll up, 1/4 roll down, inverted exit (K2)
 J.10 Top hat, 1/4 roll up, 1/4 roll down, inverted entry and exit (K2)
 J.11 Top hat from top, 3/4 roll down, 3/4pt roll up (K3)
 J.12 Top hat from top, 3/4 roll down, 3/4pt roll up, inverted entry (K3)
 J.13 Top hat from top, 3/4 roll down, 1/4 roll up (K2)
 J.14 Top hat from top, 3/4 roll down, 1/4 roll up, inverted entry (K2)
 J.15 Top hat from top, 1/4 roll down, 3/4pt roll up (K2)
 J.16 Top hat from top, 1/4 roll down, 3/4pt roll up, inverted entry (K2)1¼
 Horizontal (cross-box) flight is always flown inverted.
 K.1 45 degree up, 2/4pt roll, half loop (inside or outside), full roll down (K3)
 K.2 45 degree up, 2/4pt roll, half loop (inside or outside), full roll down, inverted entry (K3)
 K.3 45 degree up, 2/2pt roll, half loop (inside or outside), 2/4pt roll down (K3)
 K.4 45 degree up, 2/2pt roll, half loop (inside or outside), 2/4pt roll down, inverted entry (K3)
 K.5 45 degree up, full roll, half loop (inside or outside), 2/4pt roll down (K3)
 K.6 45 degree up, full roll, half loop (inside or outside), 2/4pt roll down, inverted entry (K3)
 K.7 45 degree up, 2/2pt roll, half loop (inside or outside), full snap roll down (K4)
 K.8 45 degree up, 2/2pt roll, half loop (inside or outside), full snap roll down, inverted entry (K4)
 L.1 Humpty bump (pull, pull, push) half roll up, 2/4pt roll down (K3)
 L.2 Humpty bump (push, push, pull) half roll up, 2/4pt roll down, inverted entry (K3)
 L.3 Humpty bump (pull, pull, pull) half roll up, 2/2pt roll down (K3)
 L.4 Humpty bump (push, push, push) half roll up, 2/2pt roll down, inverted entry (K3)
 L.5 Humpty bump (pull, pull, push) 2/4pt roll up, half roll down (K3)

cont/...

- L.6 Humpty bump (push, push, pull) 2/4pt roll up, half roll down, inverted entry (K3)
- L.7 Humpty bump (pull, pull, push, or pull, push, push) 1/4 roll up, 3/4 roll down (K3)
- L.8 Humpty bump (push, pull, pull, or push, push, pull) 1/4 roll up, 3/4 roll down inverted entry (K3)
- L.9 Humpty bump (pull, pull, pull) 3/4pt roll up, 1/4 roll down (K3)
- L.10 Humpty bump (push, pull, pull) 3/4pt roll up, 1/4 roll down, inverted entry (K3)
- L.11 Humpty bump with roll options, (half roll up or 1/4 roll up and down) (K2)
- L.12 Humpty bump with roll options, (half roll up or 1/4 roll up and down) inverted entry (K2)
- M.1 Humpty bump from top, half roll down (push, push, push) (K3)
- M.2 Humpty bump from top, half roll down, inverted entry (pull, pull, pull) (K2)
- M.3 Humpty bump from top, 2/4pt roll down, half roll up (push, push, pull) (K3)
- M.4 Humpty bump from top, 2/4pt roll down, half roll up, inverted entry (pull, pull, push) (K3)
- M.5 Humpty bump from top, 2/4pt roll down, 2/2pt roll up (push, push, push) (K3)
- M.6 Humpty bump from top, 2/4pt roll down, 2/2pt roll up, inverted entry (pull, pull, pull) (K3)
- M.7 Humpty bump from top, 1/4 roll down, 3/4 roll up (push, push, push) (K3)
- M.8 Humpty bump from top, 1/4 roll down, 3/4 roll up, inverted entry (pull, push, push) (K3)
- M.9 Humpty bump from top, 1/4 roll down, 3/4 roll up, inverted entry and exit (pull, push, pull) (K3)
- M.10 Humpty bump from top, 1/4 roll down, 3/4 roll up, inverted exit (push, push, pull) (K3)

5.10. CLASS F3M – LARGE RADIO CONTROLLED AEROBATIC POWER MODEL AIRCRAFT**5.10.1. Definition of a Large Radio Controlled Aerobatic Power Model Aircraft**

Model aircraft, but not a helicopter, which is aerodynamically manoeuvred by control surface(s) in attitude, direction, and altitude by a pilot on the ground using radio control.

The model aircraft must be a scaled-down version of a full-size aircraft that is able to perform aerobatics. The competitor must prove this by providing a dossier to the contest director, including a minimum of a three-view drawing and a photograph of the full-size aircraft.

5.10.2. Definition of a competition for model aircraft class F3M

A competition for model aircraft class F3M is based on three tasks:

- One task of a known schedule, valid for two years.
- One task of an unknown schedule. This unknown schedule is given to each pilot before the task, without any possibility of practising the schedule. The difficulty of this task will be equivalent to that of the known schedule.
- A freestyle schedule of the competitor's choice.

5.10.3. General Characteristics of a large R/C Aerobatic Power Model Aircraft

Minimum overall span for monoplanes 2.1 m

Minimum overall span for biplanes..... 1.8 m

Maximum flying weight without fuel..... 20 kg

Paragraph B.3.1.a) of Section 4B (Builder of Model Aircraft) is not applicable to class F3M.

For Power device limitations, Noise rule, and Radio Equipment: See 5.1.2

The maximum noise level will be 96 dB(A) measured at 3 m from the centre line of the model aircraft with the model aircraft placed on the ground over concrete or macadam at the flying site. With the motor running at full power measurement will be taken 90 degrees to the flight path on the right hand side and downwind from the model aircraft. The microphone will be placed on a stand 30 cm above the ground in line with the motor. No noise reflecting objects shall be nearer than 7 m to the model aircraft or microphone. The noise measurement will be made prior to each flight. If a concrete or macadam surface is not available then the measurement may be taken over bare earth or very short grass in which case the maximum noise level will be 94 dB(A). In the event a model aircraft fails the noise test, no indication shall be given to the pilot, and/or his team, or the judges and both the transmitter and the model aircraft shall be impounded by the flight line official immediately following the flight. No modification or adjustment to the model aircraft shall be permitted (other than refuelling). The model aircraft shall be retested by a second noise steward using a second noise meter and in the event that the model aircraft fails the retest, the score for the preceding flight shall be zero.

The flight time will be interrupted while the noise check at the flying site is being made. The competitor shall not be delayed more than 30 seconds for the noise check.

To be eligible to compete, the competitor or his helper/team manager must submit the following documentation, before the start of the competition:

- a) An accurate three-view drawing of the subject aircraft (home made drawings by the competitor or other draftsman are not acceptable).
- b) The dimensions are considered on the top view and side view of the subject aircraft.
- c) The scale of the model aircraft is calculated from the wing span.
- d) Dimensions described on the drawing overleaf can be measured. A tolerance is allowed as follows:
D is the full size measure in cm, s is scale, d is model measure in cm:
 $(D \times s) \times 0.9 - 0.5 \leq d \leq (D \times s) \times 1.1 + 0.5$

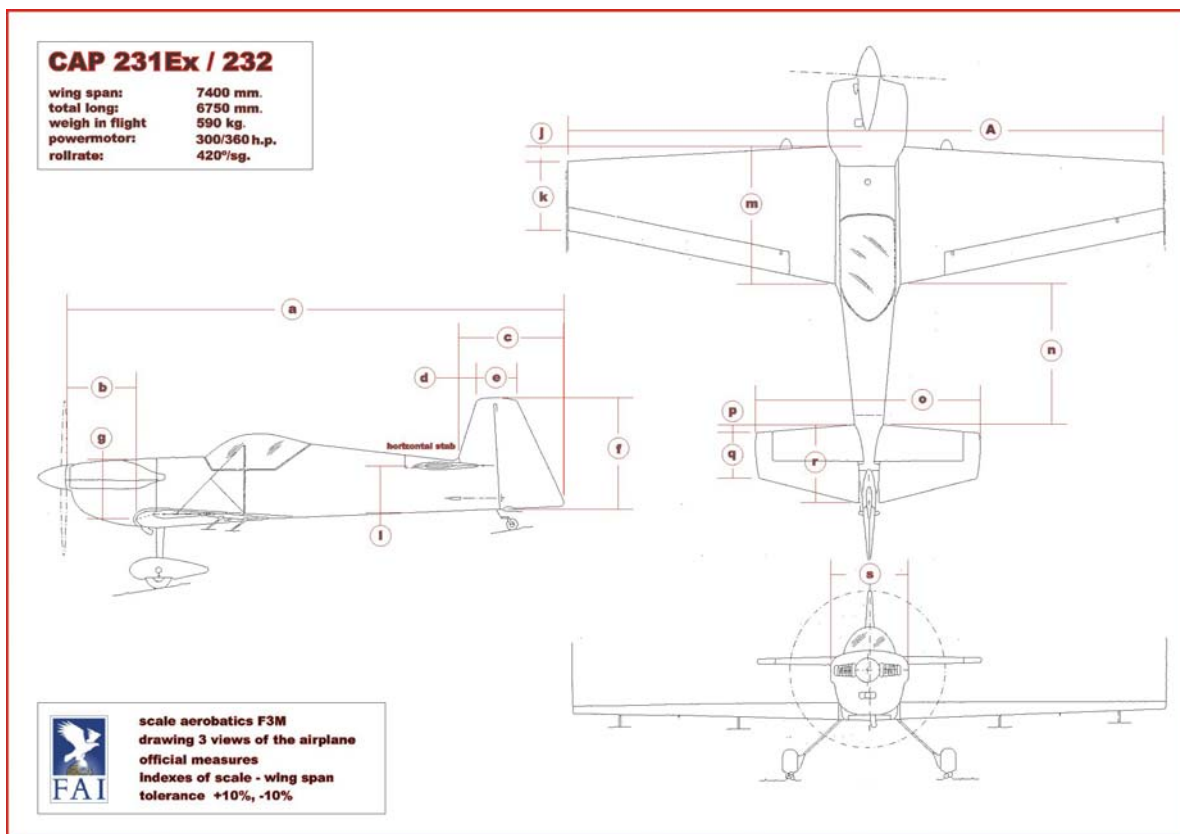

- e) The area of control surfaces compared to fixed surfaces will not be considered. Example: only the outline of the wing, stabiliser and fin will be considered, not the ailerons, elevator, or rudder, but the concept of moving surfaces must be the same as on the subject aircraft. (Aileron perhaps in two parts, moving part of the fin for aerodynamic balance, etc. Trim tabs are forbidden, if not on the full-size aircraft.)
- f) The competitor must be able to provide any technical data for technical checking. If the dimensions are not in accordance with the rules, the model aircraft is not allowed to fly and the competitor is disqualified.

5.10.4. **Definition and number of helpers:** see 5.1.3

5.10.5. **Number of flights:** Each competitor has the right to a minimum of three official flights (one known schedule + one unknown schedule + one freestyle schedule).

5.10.6. **Definition of an attempt:** see 5.1.5.

5.10.7. **Number of attempts:** see 5.1.6.

5.10.8. **Definition of an official flight:** see 5.1.7.

5.10.9. **Marking:**

- a) Each manoeuvre may be awarded marks, in whole number increments, between 10 and 0 by each of the judges during the flight. These marks are multiplied by a coefficient that varies with the difficulty of the manoeuvre.
- b) Any manoeuvre not completed shall be scored zero (0)
- c) Manoeuvres must be performed where they can be seen clearly by the judges. If a judge, for some reason outside the control of the competitor, is not able to follow the model aircraft through the entire manoeuvre, he may set the «Not Observed» (N.O.) mark. In this case, the judge's mark for that particular manoeuvre will be the average of the numerical marks given by the other judges.
- d) Centre manoeuvres should be performed in the centre of the manoeuvring area while turn around manoeuvres should not extend past a line 70 degrees left and right of centre. Vertical height should not exceed 70 degrees. Also, manoeuvres should be performed along a line of approximately 150m in front of the competitor. Infractions to this rule will be cause for downgrading by each judge individually and in proportion to the degree of infraction.

- e) The manoeuvring area will be clearly marked with white vertical poles, a minimum of 100mm in diameter and a minimum of 4m high, placed on centre, and at 70 degrees each side of centre on a line 150m in front of the competitor. Flags and/or streamers of contrasting colour should be mounted on the poles to improve visibility. White (or contrasting) lines originating at the competitor's position and extending outward at least 50m will also be used to mark the centre and extreme limits (70 degrees left and right of centre) of the manoeuvring zone. Audible and visual signals to indicate violations of the manoeuvring zone are not to be employed.
- f) The judges shall be seated no more than 10m, and not less than 7m behind the competitor's position (the apex of the 70 degree lines) and within an area described by the extension of the 70 degree lines to the rear of the competitor.
- g) At the conclusion of the flight, each judge will independently consider if the in-flight sound level of the model aircraft is too loud. If a majority of the judges consider the model aircraft too loud, the flight score will be penalised 10 points for each counting judge.
- h) If a model aircraft is in the opinion of the safety steward or the judges, unsafe or being flown in an unsafe manner, they may instruct the competitor to land the model aircraft.
- i) The scores given by each judge for each competitor shall be made public at the end of each round of competition.

5.10.10. Classification:

Classification will be done considering the sum of the three scores: known, unknown, and freestyle.

In the case where two flights of each schedule have been completed, the sum of the best known, the best unknown, and the best free-style scores will be considered.

In the case where three flights have been completed, only the best score of the repeated flight (known, unknown, and free-style) will be added to the single other flight score.

Example: one known, two unknowns, and a free-style have been completed: Classification is done by adding the known score and the free-style score to the best score of the two unknown flights.

The final classification is done by the sum of the three considered flight scores in each category, multiplied by the following coefficients:

Known 35%
 Unknown 45%
 Freestyle..... 20%

1000 points will be awarded to the competitor obtaining the highest total for his three retained flight scores. The scores are then normalised to 1000 points as described below:

$$\text{Points}_x = \frac{S_x}{S_w} \times 1000$$

Points_x = Points given to competitor x

S_x = Score of Competitor x

S_w = Score of Winner

The TBL statistical averaging system is not to be applied for the moment. However, as soon as possible, the organisers of competitions for this class may start to use scoring software using the TBL algorithm.

5.10.11. Judging:

The criteria to be applied for judging the manoeuvres in this class, are identical to class F3A. However, the judges will have to consider the dimensions and inertia of the model aircraft. The manoeuvres must be flown slower than with F3A model aircraft, but should be more realistic.

The organiser must appoint a panel of five judges. For each manoeuvre, only three scores are counted, the lowest and the highest scores being discarded.

cont/...

5.10.12. **Organisation for Large R/C Aerobatic Model Aircraft Contests**

For transmitters and frequency control, see section 4B, paragraph B.11.

The draw for flight order will be done for the first task (known, unknown, or freestyle). For the subsequent tasks, the flight order will start at 1/6, 1/3, 1/2, 2/3 and 5/6 down the list.

During the flight, the competitor must stay in front of the judges in the designated area and under the supervision of the Flight Line Director and safety steward.

Competitors must be called at least five minutes before they are required to occupy the starting area.

If his frequency is clear, the competitor will be given his transmitter when he occupies the starting area so that he can perform a radio check. Utmost care must be taken by the competitor in the starting area, to not disturb the concentration of the competitor who may be flying.

If there is a frequency conflict the competitor must be allowed a maximum of one minute for a radio check before the start of the 3-minute starting time. The timer will notify the competitor when the minute is finished, and immediately start the 3-minute starting time.

5.10.13. **Execution of manoeuvres**

The manoeuvres must be executed during an uninterrupted flight in the order in which they are listed on the score sheet. The competitor may make only one attempt at each manoeuvre during the flight. The pilot has three minutes to start his motor, and eleven minutes to complete his flight; both the three minutes and the eleven minutes to start when the competitor is given permission to start his motor.

The model aircraft must take-off and land unassisted, that is, no hand launched flights. If any part of the model aircraft is dropped during the flight, scoring will cease at that point and the competitor must be instructed to land his model aircraft immediately.

The direction of the manoeuvres is determined by the heading of the model aircraft during the take-off.

The flight ends when the landing sequence is completed.

Scoring will cease with the expiry of the eleven-minute flight period.

After the known flying schedule has been completed, the competitor is not allowed a free pass, and the landing must follow immediately. Any free passes will result in a zero score for the landing.

The model aircraft must land in the landing area, defined by a 50 metres diameter circle, or within two lines marked on the runway and separated by 100 metres if the runway is wider than 10 metres.

The landing point is considered as the first point where the model aircraft touches the ground. Landing out of the landing area, or a crash will result in a zero score for the landing.

The landing sequence is completed when the model aircraft has run for 10m or comes to a stop within 10 metres.

5.10.14. **Schedules of manoeuvres.**

- a) The **known schedule** is valid for a two-year period.
- b) The **unknown schedule** is given to the competitors in the evening preceding the competition day, or on the morning of the competition day, with no possibility of practice flying. In a proven case of a competitor having practised the unknown schedule, the competitor must be disqualified.

This schedule must be completely new, unknown, and equal in difficulty factor to the known schedule.

For each manoeuvre, judges and competitors must refer to the F3A rules that define all manoeuvres, and errors to be avoided. The same basic criteria of judging are to be used for dimensions of manoeuvres and judging of longitudinal distance (but 70° on each side, and about 150m in distance).

cont/...

Before the beginning of the task of the unknown schedule, the judging co-ordinator will brief the judges and the competitors to clearly explain the manoeuvres, and what is expected from the competitors.

Knowledge of the Aresti cryptographic system is highly recommended to all competitors and judges.

Known and unknown schedules must use patterns according to the full size FAI Aresti catalogue.

c - Freestyle schedule:

Freestyle schedules give a competitor the opportunity to demonstrate his own skill and the qualities of his model aircraft. There are no rules governing the composition of the schedules. However, safety is of prime importance.

The model aircraft flown by a competitor in the freestyle task may be different from the one flown for the two other schedules, provided this model aircraft conforms to the general characteristics of the F3M class.

The maximum duration of a freestyle flight is five (5) minutes, from the take-off signal, to the landing. The competitor will be notified at one minute before the end of the five-minute period.

After the end of the five-minute period, the judges cease to consider any further manoeuvres that may have been performed. If the model aircraft is still airborne, it must be landed immediately, otherwise the judges will mark a zero score for the criteria "Technicality of the manoeuvres" (K2).

Known schedule of manoeuvres	K-Factor
1 Triangle loop with positive snap roll on upline and 4/8-point roll on 45° line.	3
2 Stall turn with one roll and 2/2-point roll opposite on upline, 1½ negative snap roll on downline and 2/2-point roll on 45° leg.	4
3 Half loop with ¼, ½, ¾ alternate rolls on enter and ¾, ½, ¼ alternate roll on exit.	4
4 Two turn negative spin, one opposite roll.	3
5 1 ¼ positive snap roll, same direction roll, opposite ¼ roll.	4
6 Pull-push-push Humpty Bump 4-point roll on upline, opposite ¼ roll and ¼ roll on downline.	3
7 Reverse Cuban eight, one negative snap roll, 2/4-point roll opposite on leg 1, 1½ roll on leg 2, 2/4-point roll and a opposite positive snap roll on leg 3.	6
8 Teardrop with 2 positive snap rolls on 45° downline, 2 linked rolls on upline.	4
9 Diamond loop, a positive opposite snap roll and roll on leg 2, opposite roll and snap roll on leg 4.	5
10 Half square loop, a roll and 1 ¼ opposite negative snap roll.	3
11 ¾ of rolling circle with 3 alternated rolls, first inside.	5
12 45° uphill leg 1½ roll, 5/8 of a loop with one integrated full roll and a roll on exit.	4

The description of the manoeuvres, including judging notes, and the Aresti diagrams are given at Annex 5L.

5.10.15. Marking criteria – Freestyle

Judging of the Freestyle task comprises five elements. Each element contains several criteria, with marks ranging from 10 to 0. Each mark is multiplied by a difficulty coefficient (K-Factor).

Originality: Three criteria:

New Manoeuvres: K= 2

The use of completely new manoeuvres, or manoeuvres not often used, or a diverse range of manoeuvres.

Enhancers: Smoke producing devices, or streamers. K=1.

The use of these devices should be used only to accentuate or emphasise some manoeuvres. Improper or inefficient use, even if impressive, should not result in full marks being given.

Harmony with music: K= 3

If there is musical accompaniment, the flying and the manoeuvres should be in complete harmony with the music, and the music must not be used only as background.

Harmony and Rhythm: Two criteria

Setting of the manoeuvres: K= 2

The schedule must be well structured, with good placement and positioning of the manoeuvres, giving judges the best visibility of the entire performance. Safety is of prime importance.

Sequence of manoeuvres: K= 2.

The entire flight must retain the interest of judges, with a natural flow from start to finish, with coherent matching of manoeuvres.

Performing of the manoeuvres: Three criteria

Technicality of the manoeuvres: K= 2 .

Complicated and technically challenging manoeuvres must be awarded higher marks, provided there is not a lack of quality in their execution. Simple and less complex manoeuvres should attract fewer marks.

Quality: K= 2.

The entire flight must be devoid of “missed” manoeuvres, and must exhibit all-round good quality. The fact that it is a freestyle schedule must not allow the performance to become sub-standard in technicality and quality. It is not intended to be a circus performance.

Diversity: K= 2

The competitor must avoid repetitive use of the same manoeuvres, and only in exceptional circumstances will repeat manoeuvres be tolerated to emphasise a particular passage in the music.

Safety of the flight:

Safety: The impression must be created with the judges that the competitor is in absolute control of the model aircraft. The safety of persons or equipment should never be endangered during a flying performance.

5.10.16. **Safety**

The contest director will nominate a safety line officer/steward. This officer/steward is in charge of safety and will be located within hearing distance from the competitor. The safety steward must observe the model aircraft and the competitor’s actions during a flight, and is empowered to instruct a competitor to terminate his flight and to land his model aircraft immediately if necessary during a safety conflict.

During the Freestyle schedule, the distance between the manoeuvring area and the competitor must be a minimum of 20m. Any manoeuvre performed at a distance closer than 20m to the competitor will score zero marks.

Near the 20m line, model aircraft should be flown either parallel to the public line, or away from it.

The manoeuvring area frame defined for known and unknown schedules is not imposed on the Freestyle schedule. However, any flying behind the competitor will attract an immediate instruction by the safety steward for the competitor to terminate his flight, and the entire flight will score zero points.

ANNEX 5L

F3M – RADIO CONTROLLED AEROBATIC MODEL AIRCRAFT

DESCRIPTION OF MANOEUVRES – KNOWN SCHEDULE

- 1. Triangle loop with positive snap roll on upline and 4/8-point. roll on 45° line** **K=3**

Pull to a 90° climbing vertical line, perform a positive snap roll then pull to a 45° downline, perform half an 8-Point roll, then push to an horizontal inverted flight.

Possible mistakes:

 - The snap roll is not positive
 - Rotations are not in the middle of their respective lines.
 - Parts of the half 8-point roll are not equals.

- 2. Stall turn with one roll and 2/2-point roll opposite on upline, 1½ negative snap roll on downline and 2/2-point roll on 45° leg** **K=4**

From inverted, push to a vertical line, perform a roll and an opposite 2-point roll, slow down to perform a stall turn. In the downline, perform a 1½ negative snap roll, pull to a 45° downline, perform a 2-point roll and pull to an horizontal positive line.

Possible mistakes:

 - Rotations are not in the middle of their respective lines.
 - Rolls are not opposite.
 - Snap roll is not negative

- 3. Half loop with ¼, ½, ¾ alternate rolls on enter and ¾, ½, ¼ alternate roll on exit** **K=4**

From upright, perform a ¼ roll, then an opposite half roll, then an opposite ¾ roll. Immediately after push for a negative half loop. Immediately after, perform a ¾ roll, an opposite half roll and a ¼ opposite roll.

Possible mistakes:

 - Rolls are not opposites.
 - The half loop does not start or end on the centre line.
 - Rotations does not stop exactly on knife-edge or on horizontal flight.
 - The half loop is not round.

- 4. Two turn negative spin** **K=3**

From inverted, perform two consecutive inverted (negative) spins followed by an opposite roll and push to exit inverted.

Possible mistakes:

 - Entry is a snap roll : zero points.
 - Entry is forced.
 - Roll is not opposite to spin.

- 5. 1¼ positive snap roll, same direction roll, opposite ¼ roll** **K=4**

From upright, perform a 1¼ snap roll, one roll in the same direction, half a roll, and one opposite ¼ roll.

Possible mistakes:

 - The figure is not centred.
 - Rotations does not stop exactly on knife-edge or on horizontal flight.

- 6. Pull-Push-Push Humpty Bump 4-point roll on upline, opposite ¼ roll and ¼ roll on downline** **K=3**

From upright, pull to a vertical line, perform a 4-point roll, push half a loop to a vertical line, perform ¼ roll and ¼ opposite roll, then push to inverted flight.

Possible mistakes:

 - Rotations are not in the middle of their respective lines.
 - The two ¼ rolls are not opposite.

- 7. Reverse Cuban eight, one negative snap roll, 2/4-point roll opposite on leg 1, 1½ roll on leg 2, 2/4-point roll and a opposite positive snap roll on leg 3** **K = 6**
- From inverted perform an inverted Cuban eight. On the first 45°, perform a negative snap roll followed by an opposite 2/4-point roll, one and a half roll on the second 45° line and a 2/4-point roll followed by an opposite positive snap roll on the third 45° line. Exit upright on high level.
- Possible mistakes:**
- The two ¾ loop are not the same radius.
 - The two ¾ loop are not round.
 - Rotations are not in the middle of their respective lines.
 - Rotations are not in opposite directions.
- 8. Teardrop with 2 positive snap rolls on 45° downline, 2 linked rolls on upline** **K=4**
- From upright, push to a 45° downline, perform 2 positive snap rolls, push 5/8 of loop to a vertical line, perform 2 full rolls, push to an inverted flight on high level.
- Possible mistakes:**
- Rotations are not in the middle of their respective lines.
- 9. Diamond loop, a positive opposite snap roll and roll on leg 2, opposite roll and snap roll on leg 4** **K = 5**
- From negative, perform an inverted square loop on corner. On the second leg, perform a positive snap roll followed by an opposite roll. On the third leg, perform a roll and an opposite snap roll. Exit inverted.
- Possible mistakes:**
- Rotations are not in the middle of their respective lines.
 - Rolls and snaps are not opposite.
- 10. Half square loop, a roll and 1 ¼ opposite negative snap roll** **K= 3**
- From inverted, pull to a vertical line, perform a full roll and 1¼ opposite negative snap roll, then push to an inverted flight.
- Possible mistakes:**
- Rotations are not in the middle of their respective lines.
 - Roll and snap are not opposite.
- 11. ¾ of rolling circle with 3 alternated rolls, first inside** **K=5**
- From inverted, perform ¾ of a rolling circle (away from, or towards the runway), with three rolls in opposite directions. The first roll is to the inside of the circle. Exit inverted.
- Possible mistakes:**
- Roll rate must be constant and continuous.
 - Roll reversal must be immediate.
 - Circle must be of constant radius and wind corrected.
- Manoeuvre must be downgraded if the circle is too large, and too far out. If the competitor chooses to perform the circle towards the runway, the manoeuvre must be downgraded if any portion of the circle is outside of the manoeuvring zone.
- 12. 45° uphill leg 1½ roll, 5/8 of a loop with one integrated full roll and a roll on exit** **K=4**
- From inverted, push to a 45° line, perform 1½ roll, then 5/8 of a loop with an integrated roll on its top, finally a full roll on exit.
- Possible mistakes:**
- The roll is not integrated.
 - The exit roll is not performed immediately after the loop.

The Aresti diagrams appear overleaf.

F3M KNOWN SCHEDULE OF MANOEUVRES 2012-2013

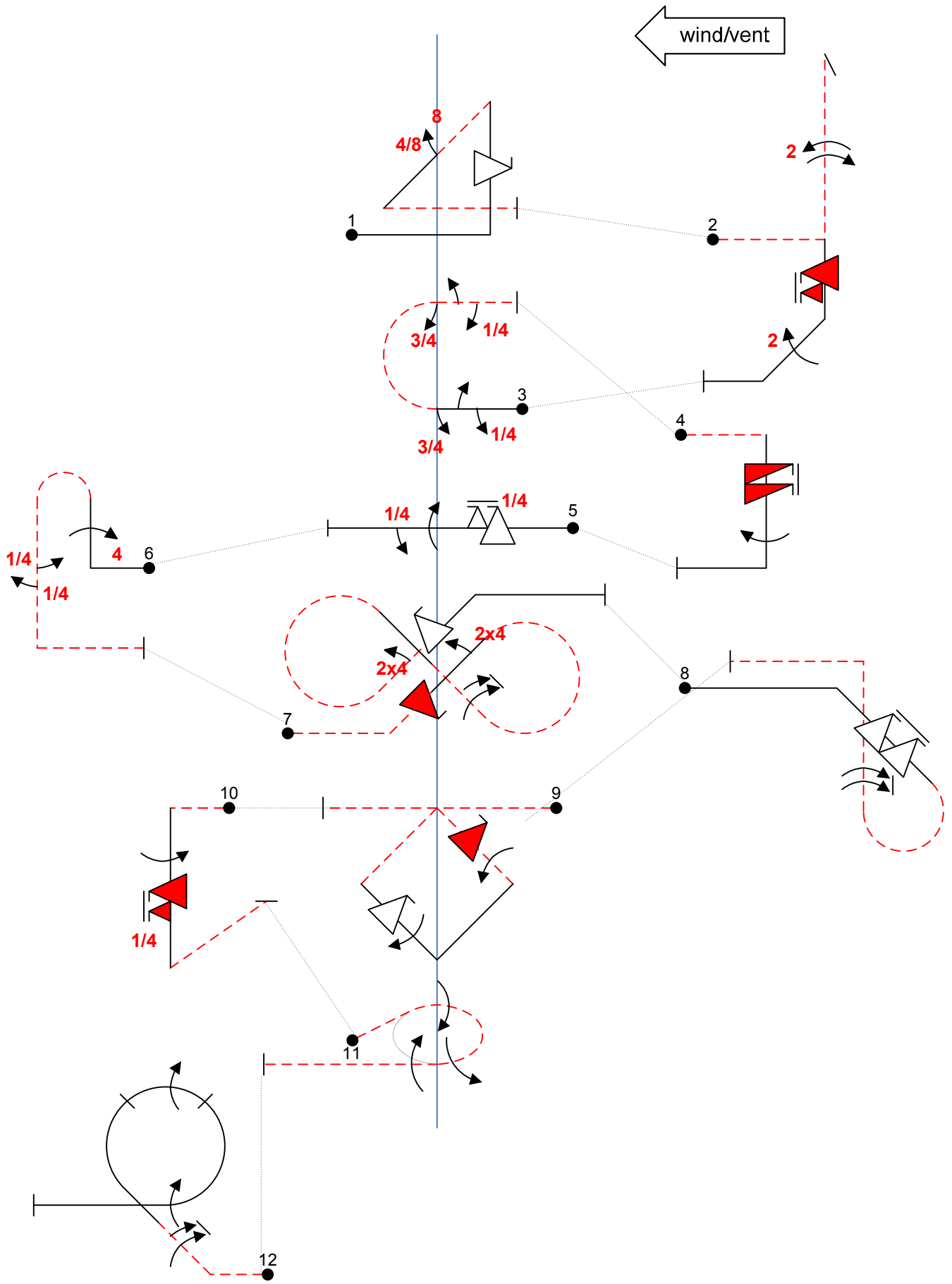

PAGE DELIBERATELY LEFT BLANK

5.9. CLASS F3P – INDOOR RADIO CONTROL AEROBATIC POWER MODEL AIRCRAFT

5.9.1 Definition of an R/C Indoor Aerobatic Power Model Aircraft

As 5.1.1 except that variable thrust direction of the propulsion device(s) is allowed for F3P-AFM.

5.9.2 General Characteristics of R/C Indoor Aerobatic Power Model Aircraft

As 5.1.2 except for the following:

Maximum total weight.....300g

External parts that protrude which could be considered dangerous, (ie landing gear struts, shaft tips etc) must be covered in order to avoid injuries.

Power device limitations: any suitable power device may be utilised except those generating any kind of exhaust emission.

5.9.3 Definition and Number of Helpers

See 5.1.3 except for the following:

A helper may be a Team Manager, another competitor or an officially registered supporter. Each pilot is permitted one helper during the flight.

5.9.4 Number of Flights

Competitors have the right to the same number of flights. Only completed rounds will be counted.

5.9.5 Definition of an Attempt

See 5.1.5

5.9.6 Number of Attempts

See 5.1.6

5.9.7 Definition of an Official Flight

See 5.1.7

5.9.8 Marking

See 5.1.8 except for the following:

- (a) The manoeuvring area is limited by the floor, ceiling, and walls of the hall, as well as by the safety line which is parallel to the longest wall of the hall and in front of the judges. A model aircraft must never cross this safety line. The centre line of the manoeuvring area stretches from the safety line (perpendicular) to the opposite long wall, and is positioned in the middle between the side walls. The competitor is normally placed on the intersection of the safety line and the centre line.
- (b) The recommended dimensions of the hall should be about 40 x 20 metres in length and width and between 8 to 12 metres in height.
- (c) Centre manoeuvres should be positioned equally above the centre line of the manoeuvring area, with turn around manoeuvres at the left or right of it. Infractions of this rule will be cause for downgrading by each judge individually and in proportion to the degree of infraction.
- (d) Aerobatics Freestyle to Music (AFM) are judged for flying style, artistic quality, and overall performance, in marks of whole number increments between 10 and 0 by each of the judges for the overall flight.
- (e) Judges shall be seated on a line parallel to the longest wall of the hall and in the middle between its side walls, while viewing the opposite longest wall.

5.9.9 Classification

See 5.1.9 except for the following:

For World and Continental Championships, each competitor will have four (4) preliminary flights (schedule F3P-AP), with the best three normalised scores to determine the preliminary ranking. The top 20% (twenty percent) of the classified competitors with a minimum of five (5) will have three (3) additional flights. These final flights will be flown as a known, finals schedule (schedule F3P-AF). The total of the best three preliminary flights normalised again to 1000 points will count as one score. This score and the

three finals scores will give four (4) normalised scores. The sum of the three best will give the final classification. In the case of a tie, the sum of all the four (4) scores will determine the winner.

Note 1: Final flights to determine the individual winner are only required for World and Continental Championships

5.9.10 Judging

- a) For each competition in F3P, there must be a minimum of three (3), and a maximum of five (5) judges, plus one timer.
- b) For larger events, there might be several panels of judges.
- c) For World or Continental Championships the organiser must appoint one or more panels of five judges each. The judges must be of different nationalities and must be selected from a current list of international Judges. Those selected must reflect the approximate geographical distribution of teams having participated in the previous World Championships (if applicable) and the final list must be approved by the CIAM Bureau.
- d) The invited judges for World or Continental Championships must be selected from a current list of FAI international judges and must have had F3P judging experience within the previous twelve months and must submit a resume of his judging experience to the organiser when accepting the invitation to judge at a World or Continental Championship. The organiser must in turn submit the resumes to the CIAM Bureau for approval.
- g) To avoid errant judging, it is recommended that training flights be performed, before the beginning of official flying. These training flights are judged and tabulated according to the regulations, but the results are not made public.

5.9.11 Organisation for R/C Indoor Aerobatic Contests

See 5.1.11 except for the following:

- a) If his FM frequency is clear the competitor will be given his FM transmitter when he occupies the starting area so that he can perform a radio check. If there is a FM frequency conflict he must be allowed a maximum of one (1) minute for a radio check before the start of the one (1) minute starting time. The timer will notify the competitor when the minute is finished and immediately start timing the one (1) minute starting time. According to paragraph 5.1.2. the voltage of the propulsion battery of electric powered models must be checked by an official in the preparation area before the 1-minute starting time is started.

5.9.12 Execution of Manoeuvres

- a) In the preliminary flights (schedule F3P-AP) and the finals flights (schedule F3P-AF), the manoeuvres must be executed during an uninterrupted flight in the order that they are listed in the schedule. The competitor may make only one attempt at each scored manoeuvre during the flight. The direction of take-off is the pilot's choice. The direction of the first manoeuvre determines the direction of all following manoeuvres.
- b) In schedules with turn around manoeuvres, there is no unjudged flying between the first manoeuvre after the take-off and the last manoeuvre before landing.
- c) In AFM, judging is done for the entire flight, without interruption.
- d) If the model aircraft touches the floor, ceiling, walls, or any structures or fixtures of the hall, or crosses the safety line during a manoeuvre, this manoeuvre is scored ZERO.
- e) In AFM this rule only applies regarding the safety line.
- f) The competitor may make only one attempt at each manoeuvre during the flight. The pilot has one (1) minute starting time and five (5) minutes to complete his flight, both the one (1) minute and the five (5) minutes begin when the competitor is given permission to start.
- g) In AFM the competitor has to signal the operator of the music his wish to start the music within the first minute.
- h) The duration of the music must be 120 +/- 5 seconds. Judging of the flight starts with its beginning.
- i) The model aircraft must take-off and land unassisted, that is, no hand launched flights. If any part of the model aircraft is dropped or if it comes to stand still during the flight, scoring will cease at that point and the model must be landed immediately.

- j) In AFM this rule only applies regarding the take-off.
- k) Scoring will cease at the expiry of the five (5) minutes time limit.
- l) In AFM the flight ends at the stop of the music, or 125 seconds after it had started. At least then the model aircraft has to be landed.

5.9.13 Schedule of Manoeuvres

The schedule F3P-AP is a preliminary schedule for expert pilots in Indoor Aerobatic Power Model Aircraft competitions.

The schedule F3P-AF is a finals schedule for expert pilots in Indoor Aerobatic Power Model Aircraft competitions.

The schedule F3P-AFM is for competitors to demonstrate their artistic performances in Indoor Aerobatic Power Model Aircraft in conjunction with music. It is recommended that competitors in F3P-AFM have to go through a prequalification in F3P-AP and F3P-AF first.

SCHEDULE F3P-AP-13 (2012-2013)

	K-Factor
AP-13.01 Square Loop with ½ roll up, ½ roll down	K= 3
AP-13.02 Top Hat with ¼ roll up, ½ roll, ¼ roll down	K= 4
AP-13.03 Roll Combination with consecutive two rolls in opposite directions	K= 5
AP-13.04 Stall Turn with ¼ roll up, ¼ roll down	K= 3
AP-13.05 Horizontal Circle 8 with ¼ roll, roll, ¾ roll in opposite directions	K= 5
AP-13.06 Push-Push-Pull Humpty-Bump with ¼ roll up (Option: Push-Pull-Pull, ¼ roll down)	K= 3
AP-13.07 Loop with ¼ roll, ¼ roll in opposite directions integrated	K= 3
AP-13.08 ½ Horizontal Square Circle with ¼ roll, four consecutive ⅛ rolls, ¼ roll	K= 4
AP-13.09 1 ½ Torque Rolls	K= 6
AP-13.10 ½ Square Loop with ½ roll up	K= 2
AP-13.11 45° Downline with two consecutive ¼ rolls	K= 4

	K=42

SCHEDULE F3P-AF-13 (2012-2013)

	K-Factor
AF-13.01 Knife-edge Loop with ½ roll	K= 4
AF-13.02 Stall Turn, 1 ½ roll up, ½ roll down	K= 3
AF-13.03 Roll Combination with two consecutive ¼ rolls, two consecutive ¼ rolls in opposite directions	K= 5
AF-13.04 Shark Fin with four consecutive ⅛ rolls up, ½ roll down	K= 4
AF-13.05 Horizontal Circle with three consecutive rolls in opposite directions	K= 5
AF-13.06 Trombone with ¼ roll, ¼ roll	K= 2
AF-13.07 Six-sided Loop with ½ roll	K= 3
AF-13.08 ½ Horizontal Square Circle with ¼ roll, two consecutive 1/2 rolls in opposite directions, ¼ roll	K=4
AF-13.09 Knife-edge Cuban 8 with ¼ roll, ½ roll, ¼ roll	K= 6
AF-13.10 ½ Square Loop with ½ roll down	K= 3
AF-13.11 Two consecutive ¾ Torque Rolls in opposite directions	K= 6

	K=45

The descriptions of the manoeuvres and the Aresti diagrams for F3P-AP and F3P-AF appear at Annex 5M.

An explanation of the Aresti diagrams appears in F3A Annex 5A.

The Manoeuvre Execution Guide appears in F3A Annex 5B.

cont/...

SCHEDULE F3P-AFM

AM1. Take-off

AM2. Freestyle (freely composed sequence of manoeuvres choreographed to music of the competitor's choice.)

AM3. Landing

The description of the manoeuvres for F3P-AFM appear at the end of Annex M.

ANNEX 5M**F3P – RADIO CONTROLLED AEROBATIC MODEL AIRCRAFT****DESCRIPTION OF MANOEUVRES****Preliminary Manoeuvres – Schedule F3P-AP-13 (2012-2013)****AP-13.01 Square Loop with $\frac{1}{2}$ roll up, $\frac{1}{2}$ roll down**

From upright, pull through a $\frac{1}{4}$ loop into a vertical upline, perform a $\frac{1}{2}$ roll, push through a $\frac{1}{4}$ loop into a horizontal line, push through a $\frac{1}{4}$ loop into a vertical downline, perform a $\frac{1}{2}$ roll, pull through a $\frac{1}{4}$ loop, exit upright.

AP-13.02 Top Hat with $\frac{1}{4}$ roll up, $\frac{1}{2}$ roll, $\frac{1}{4}$ roll down

From upright, pull through a $\frac{1}{4}$ loop into a vertical upline, perform a $\frac{1}{4}$ roll, pull into a horizontal cross – box line, perform a $\frac{1}{2}$ roll, push through a $\frac{1}{4}$ loop into a vertical downline, perform a $\frac{1}{4}$ roll, push through a $\frac{1}{4}$ loop, exit inverted.

AP-13.03 Roll Combination with consecutive two rolls in opposite directions

From inverted, perform a roll consecutively followed by another roll in opposite direction, exit inverted.

AP-13.04 Stall Turn with $\frac{1}{4}$ roll up, $\frac{1}{4}$ roll down

From inverted, push through a $\frac{1}{4}$ loop into a vertical upline, perform a $\frac{1}{4}$ roll, perform a stall turn into a vertical downline, perform a $\frac{1}{4}$ roll, push through a $\frac{1}{4}$ loop, exit inverted.

AP-13.05 Horizontal Circle 8 with $\frac{1}{4}$ roll, roll, $\frac{3}{4}$ roll in opposite directions

From inverted, perform a $\frac{1}{4}$ horizontal circle while performing $\frac{1}{4}$ roll to the outside, then, while performing a roll in the opposite direction, perform immediately another (full) circle in the opposite, then, while performing a $\frac{3}{4}$ roll again in the opposite direction, finish the remaining $\frac{3}{4}$ of the first circle, exit inverted.

AP-13.06 Push-Push-Pull Humpty-Bump with $\frac{1}{4}$ roll up (Option: Push-Pull-Pull, $\frac{1}{4}$ roll down)

From inverted push into a vertical upline, perform a $\frac{1}{4}$ roll, push through a $\frac{1}{2}$ cross-box loop into a vertical downline, pull through a $\frac{1}{4}$ loop, perform a $\frac{1}{4}$ horizontal circle, exit upright.

Option: from inverted, perform a $\frac{1}{4}$ horizontal circle, push into a vertical upline, pull through a $\frac{1}{2}$ cross-box loop into a vertical downline, perform a $\frac{1}{4}$ roll, pull through a $\frac{1}{4}$ loop, exit upright.

AP-13.07 Loop with $\frac{1}{4}$ roll, $\frac{1}{4}$ roll in opposite directions integrated

From upright, pull through a loop, while performing a $\frac{1}{4}$ roll integrated into the second quarter of the loop and another $\frac{1}{4}$ roll in opposite direction integrated in the third quarter of the loop, exit upright.

AP-13.08 Half Horizontal Square Circle with $\frac{1}{4}$ roll, four consecutive $\frac{1}{8}$ rolls, $\frac{1}{4}$ roll

From upright, perform a $\frac{1}{4}$ roll, perform a $\frac{1}{4}$ circle into a horizontal cross-box knife-edge line, perform consecutively four $\frac{1}{8}$ rolls, perform a $\frac{1}{4}$ circle, perform a $\frac{1}{4}$ roll, exit upright.

AP-13.09 $1\frac{1}{2}$ Torque Rolls

From upright, reduce flying speed until the longitudinal axis of the model aircraft is in a vertically hovering attitude. Perform $1\frac{1}{2}$ torque rolls in this position, then accelerate to exit inverted.

AP-13.10 Half Square Loop with $\frac{1}{2}$ roll up

From inverted, push through a $\frac{1}{4}$ loop into a vertical upline, perform a $\frac{1}{2}$ roll, pull through a $\frac{1}{4}$ loop, exit inverted.

AP-13.11 45° Downline with two consecutive $\frac{1}{4}$ rolls

From inverted, pull through a $\frac{1}{8}$ loop into a 45° downline, perform consecutively two $\frac{1}{4}$ rolls, pull through a $\frac{1}{8}$ loop, exit upright.

The Aresti diagrams appear overleaf.

F3P PRELIMINARY SCHEDULE AP-13 (2012-2013)

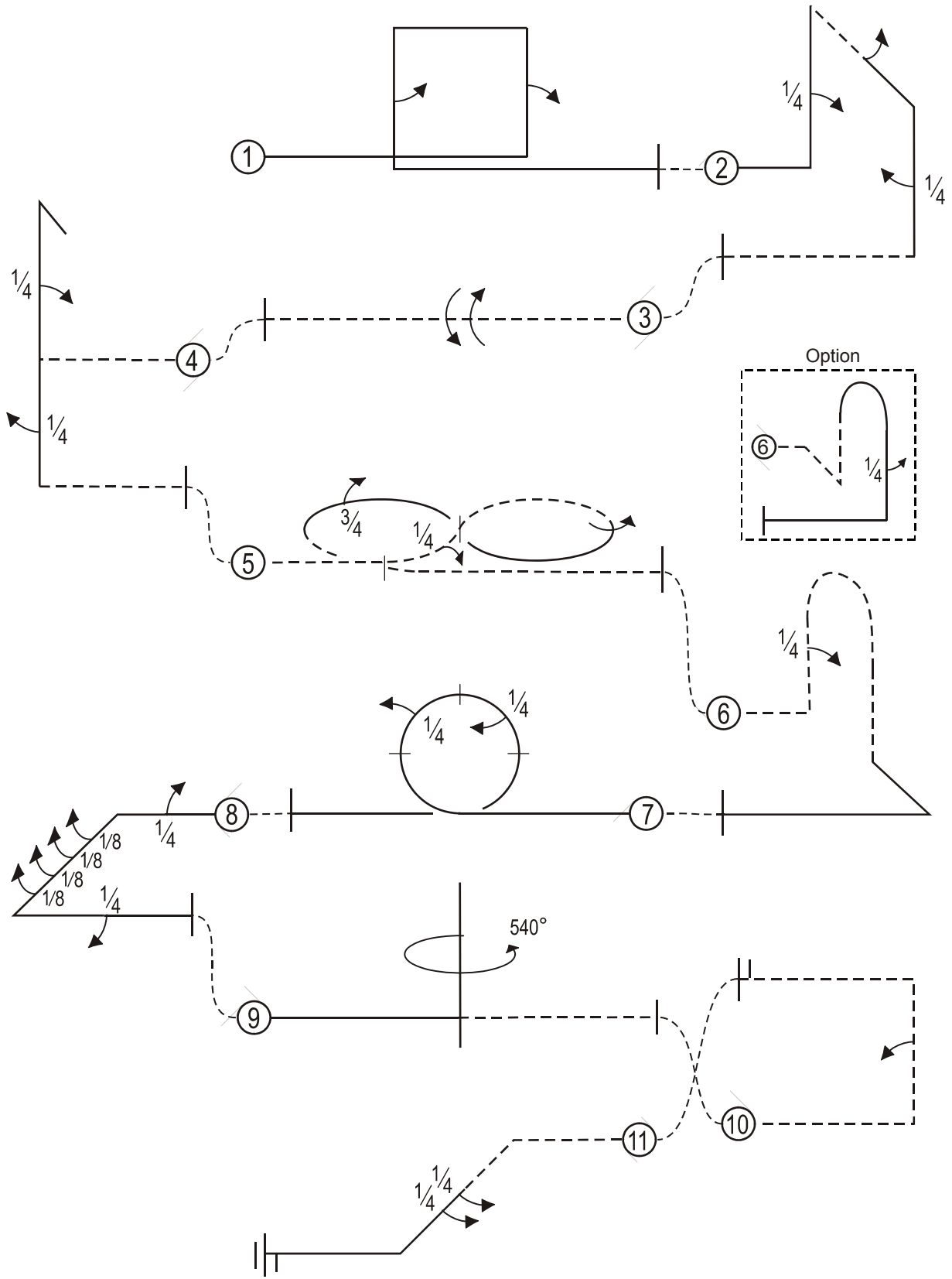

Drawings by Ken Hirose
June 2011

Finals Manoeuvres – Schedule F3P-AF-13 (2012-2013)**AF-13.01 Knife-edge Loop with $\frac{1}{2}$ roll**

From upright, perform a $\frac{1}{4}$ roll, perform a knife-edge loop while performing a $\frac{1}{2}$ roll integrated in the top 90° of the loop, perform a $\frac{1}{4}$ roll, exit inverted.

AF-13.02 Stall Turn, 1 $\frac{1}{2}$ roll up, $\frac{1}{2}$ roll down

From inverted, push through a $\frac{1}{4}$ loop into a vertical upline, perform $1\frac{1}{2}$ rolls, perform a stall turn into a vertical downline, perform a $\frac{1}{2}$ roll, push through a $\frac{1}{4}$ loop, exit inverted.

AF-13.03 Roll Combination with two consecutive $\frac{1}{4}$ rolls, two consecutive $\frac{1}{4}$ rolls in opposite directions

From inverted, perform consecutively two $\frac{1}{4}$ rolls, perform consecutively another two $\frac{1}{4}$ rolls in opposite direction, exit inverted.

AF-13.04 Shark Fin with four consecutive $\frac{1}{8}$ rolls up, $\frac{1}{2}$ roll down

From inverted, push through a $\frac{1}{4}$ loop into a vertical upline, perform consecutively four $\frac{1}{8}$ rolls, pull through a $\frac{5}{8}$ loop into a 45° downline, perform a $\frac{1}{2}$ roll, pull through a $\frac{1}{8}$ loop, exit upright.

AF-13.05 Horizontal Circle with three consecutive rolls in opposite directions

From upright, perform a horizontal circle while performing a roll to the outside integrated in the first 120° of the circle, consecutively followed by another roll in the opposite direction integrated in the second 120° of the circle, and consecutively followed by another roll in opposite direction integrated in the final 120° of the circle, exit upright.

AF-13.06 Trombone with $\frac{1}{4}$ roll, $\frac{1}{4}$ roll

From upright pull through a $\frac{1}{8}$ loop into a 45° upline perform a $\frac{1}{4}$ roll, push through a $\frac{1}{2}$ circle into a 45° downline, perform a $\frac{1}{4}$ roll pull through a $\frac{1}{8}$ loop, exit upright.

AF-13.07 Six-sided Loop with $\frac{1}{2}$ roll

From upright, pull through a six-sided loop while performing a $\frac{1}{2}$ roll in the third leg, exit inverted.

AF-13.08 $\frac{1}{2}$ Horizontal Square Circle with $\frac{1}{4}$ roll, two consecutive $1/2$ rolls in opposite directions, $\frac{1}{4}$ roll

From inverted, perform a $\frac{1}{4}$ roll, perform a $\frac{1}{4}$ circle into a horizontal cross-box knife-edge line, perform consecutively two $\frac{1}{2}$ rolls in opposite directions, perform a $\frac{1}{4}$ circle, perform a $\frac{1}{4}$ roll, exit upright.

AF-13.09 Knife-edge Cuban 8 with $\frac{1}{4}$ roll, $\frac{1}{2}$ roll, $\frac{1}{4}$ roll

From upright pull through a $\frac{1}{8}$ loop into a 45° upline, perform $\frac{1}{4}$ roll, perform a $\frac{3}{4}$ knife-edge loop, perform a $\frac{1}{2}$ roll, perform another $\frac{3}{4}$ knife-edge loop, perform a $\frac{1}{4}$ roll, push through a $\frac{1}{8}$ loop, exit upright.

AF-13.10 $\frac{1}{2}$ Square Loop with $\frac{1}{2}$ roll down

From upright, push through a $\frac{1}{4}$ loop into a vertical downline, perform a $1/2$ roll, push through a $\frac{1}{4}$ loop, exit upright.

AF-13.11 Two consecutive $\frac{3}{4}$ Torque Rolls in opposite directions

From upright, reduce flying speed until the longitudinal axis of the model aircraft is in a vertically hovering attitude. Perform in this position a $\frac{3}{4}$ torque roll and consecutively another $\frac{3}{4}$ torque roll in opposite direction, then accelerate to exit upright.

The Aresti diagrams appear overleaf.

F3P PRELIMINARY SCHEDULE AF-13 (2012-2013)

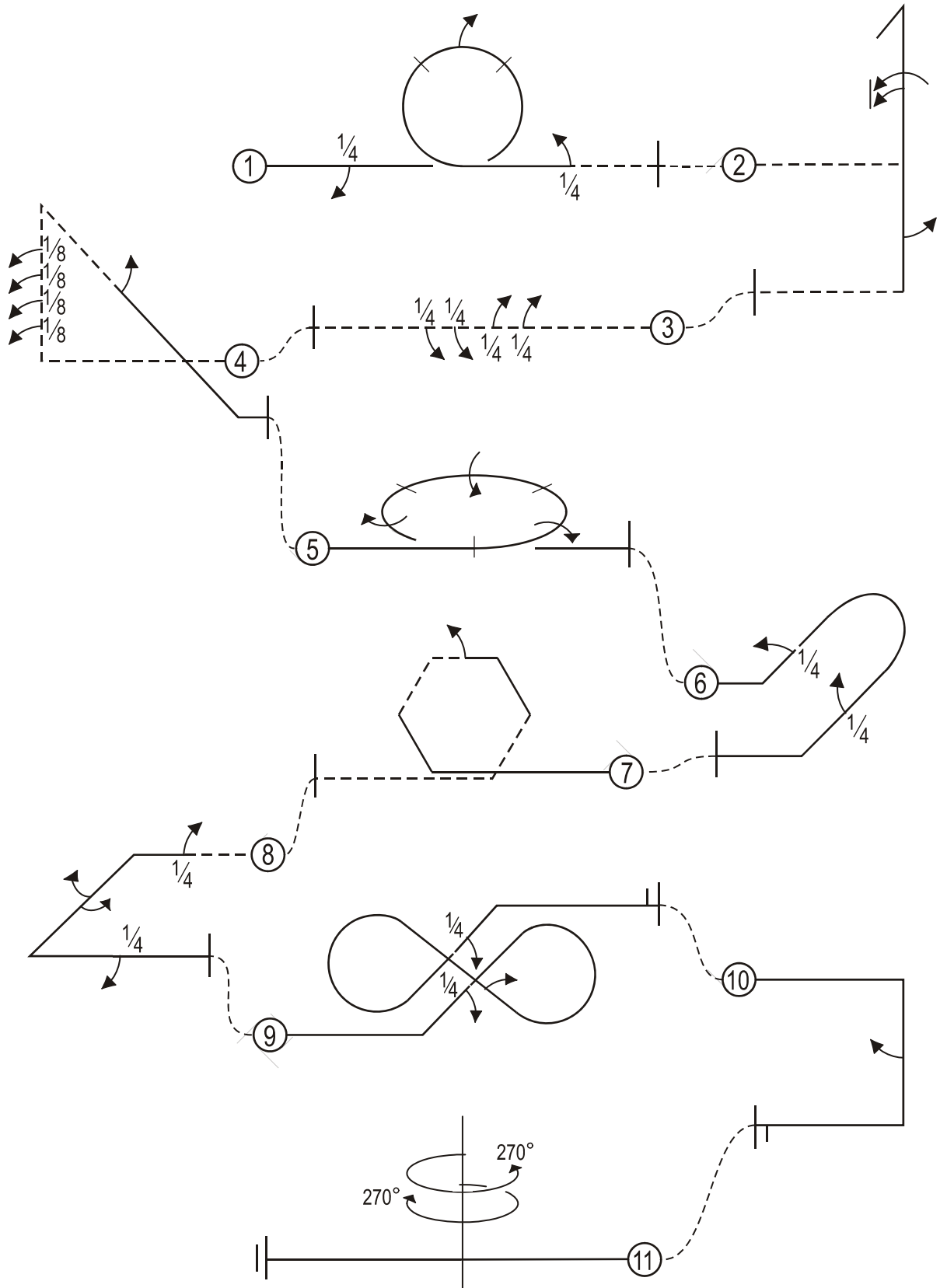

Drawings by Ken Hirose
June 2011

Manoeuvres – Schedule F3P-AFM

AFM1. Take-off Sequence

Place the model aircraft on the floor and take-off.

AFM2. Freestyle

A sequence of manoeuvres, freely composed by the competitor and flown in harmony to simultaneously played music of his choice. Any possible flight manoeuvres may be flown and "show effects" presented, as long as safety is not compromised and conformity to the rules is met. It is permitted to perform different programs in conjunction with different music in each round. The performance is judged for the entire flight from start to finish and in accordance to the following three criteria:

	K Factors
1 Flying Style	
- Precision of manoeuvres	2
- Utilisation of flight performance scope/difficulty of manoeuvres	2
-Variety of manoeuvres/new manoeuvres	2
2 Artistic Quality	
- Synchronisation to music	3
- Reflection of the mood of the music/show effects	2
- Sequence of quiet and dynamic phases	1
3 Overall Impression	
- Utilisation of manoeuvring area	2
- Continuity of schedule	2
- Positioning/safety	2

Judges Notes:

Unlike class F3A, although accompanied by its basic rules, F3P-AFM mostly focuses on spectator and media efficacy. This is why the performances should be extraordinarily spectacular and entertaining under these aspects.

For the Judges it is recommended to make "pencil" notes right away during the presentation. So corrections are still possible in course of the flight. All three criteria have to be marked simultaneously and evenly.

Although it is subjective, judging the presentations has to follow the judging guide and judging notes. Bias in favour of, or against, particular persons, models, music pieces etc must not influence the judging.

1 Flying Style

The flying skills of the pilot count herein. Flight sections and manoeuvres should be precise in the sense of F3A. Difficult manoeuvres are marked higher. The pilot is to demonstrate that he safely governs his model in any position. (Judges Guide F3A Annex 5B)

In addition, the pilot is to utilise the full flight performance scope of his model. Fast and slow flying, snap manoeuvres, hovering etc. The manoeuvres should show positive as well as negative "g"-portions: loops, rolls, snaps, spins, stall-turns, tailslides, hovering, torque-rolls, flat circles, Lomcevacs, circles, etc. New or extraordinary manoeuvres are marked higher. Frequent repetition of the same manoeuvre has to be downgraded respectively. Manoeuvres should be positioned in parallel or rectangular to the safety line. Poorly governed, unplanned or casually flown manoeuvres will be downgraded. The same applies to phases less extraordinarily attractive.

cont/...

2 Artistic Quality

The music (choreography) has to enhance the presentation and to create a complimentary atmosphere. The flight performance should be synchronised with the music and must not be a "3D-sketch" with background music. On the other hand the music must not detract from the presentation. The selected music piece(s) should contain fast-slow, soft-loud and dramatic sections. The manoeuvres should follow the music and end with it. The mood of the selected music should be reflected in the manoeuvres and the presentation. Show effects can support this. Music pieces with little contrast, variety or tempi result in downgrades.

3 Overall impression

A well made combination of flying style-music-entertainment is desired. The presentation should fill the manoeuvring area and form an uninterrupted unit with fluent transitions between the individual elements. Various thrill effects are requested. The performance should be orientated towards judges and spectators, although risky flying towards judges and spectators will result in downgrades.

AFM3. Landing Sequence

The termination of the flight in any kind of way provided it is performed in a safe manner

5.12 CLASS F3S – RADIO CONTROLLED AEROBATIC POWER JET MODEL AIRCRAFT**5.12.1 Definition of a Radio Controlled Aerobatic Power Jet Model Aircraft**

Model aircraft, but not a helicopter, which is aerodynamically manoeuvred by control surface(s) in attitude, direction, and altitude by a pilot on the ground using radio control.

5.12.2 General Characteristics of a R/C Aerobatic Power Jet Model Aircraft

- a) The R/C Aerobatic Power Jet Model Aircraft shall use as a propulsion device either
 - a) turbo jet/s or
 - b) ducted fan/s.

Ducted fans may use piston engines or electric motors as a power source.

- b) The number of model aircraft eligible for entry is two (2).
- c) Paragraph B.3.1.a) of Section 4B (Builder of Model Aircraft) is not applicable to class F3S.
- d) For power device limitations, noise rule, and radio equipment: See 5.1.2
- e) Noise limits apply to model aircraft with piston engines only.

5.12.3. Definition and number of helpers

See 5.1.3

5.12.4 Number of flights

Each competitor has the right to three official flights.

5.12.5 Definition of an attempt

See 5.1.5.

5.12.6 Number of attempts

See 5.1.6.

5.12.7 Definition of an official flight:

See 5.1.7.

5.12.8 Marking:

- a) Each manoeuvre may be awarded marks, in half (0.5) increments, between 10 and 0 by each of the judges during the flight. These marks are multiplied by a coefficient that varies with the difficulty of the manoeuvre. Any manoeuvre not completed shall be scored zero (0). Manoeuvres must be performed where they can be seen clearly by the judges. If a judge, for some reason outside the control of the competitor, is not able to follow the model aircraft through the entire manoeuvre, he may set the «Not Observed» (N.O.) mark. In this case, the judge's mark for that particular manoeuvre will be the average of the numerical marks given by the other judges.
- b) Centre manoeuvres should be performed in the centre of the manoeuvring area while turn around manoeuvres should not extend past a line 75 degrees left and right of centre. Also, manoeuvres should be performed along a line of approximately 150 to 200 m (depending on the size of the model aircraft) in front of the competitor.
- c) Infractions to this rule will be cause for downgrading by each judge individually and in proportion to the degree of infraction.
- d) The manoeuvring area will be clearly marked with white vertical poles, a minimum of 100mm in diameter and a minimum of 4m high, placed on centre, and at 75 degrees each side of centre. Flags and/or streamers of contrasting colour should be mounted on the poles to improve visibility. White (or contrasting) lines originating at the competitor's position and extending outward at least 50m will also be used to mark the centre and extreme limits (75 degrees left and right of centre) of the manoeuvring zone. Audible and visual signals to indicate violations of the manoeuvring zone are not to be employed.
- e) The judges shall be seated no more than 10m, and not less than 7m behind the competitor's position (the apex of the 75 degree lines) and within an area described by the extension of the 75 degree lines to the rear of the competitor.
- f) If a model aircraft is in the opinion of the safety steward or the judges, unsafe or being flown in an unsafe manner, they may instruct the competitor to land the model aircraft.
- g) The scores given by each judge for each competitor shall be made public at the end of each round of competition.

5.12.9 Classification:

- a) For every competitor the individual result of each round is normalised to the points of the best competitor of that round as follows:

$$\text{Points}_x = \frac{S_x}{S_w} \times 1000$$

Points_x = points awarded to competitor X

S_x = score of competitor X

S_w = score of winner of round

- b) The normalised points shall be recorded to the first decimal number.
 c) The final classification will be done considering the sum of the scores of the best two attempts.
 d) In order to decide the winner when there is a tie, the discarded flight score shall be taken into (a) account.
 e) The TBL statistical averaging system is not to be applied

5.12.10 Judging:

- a) The criteria to be applied for judging the manoeuvres in this class, are identical to class F3A. However, the judges will have to consider the dimensions, inertia and speed of the jet model aircraft.
 b) The organiser must appoint a panel of least three up to five judges, preferably. When five judges are used the lowest and highest scores for each manoeuvre will be discarded.

5.12.11 Organisation for Aerobatic Power Jet Model Aircraft Contests

- a) For transmitters and frequency control, see section 4B, paragraph B.11.
 b) The flight order for the first round will be determined by draw. In case of frequency conflicts the flight order may be changed by the contest director. For second round, the flight order will start at 1/3 down the list. For third round, the flight order is the reversed ranking after second round.
 c) During the flight, the competitor must stay in front of the judges in the designated area and under the supervision of the Flight Line Director and safety steward.
 d) The prohibited flying area is observed by the judges. If the safety line is crossed the flight will be scored zero points.
 e) Competitors must be called at least ten (10) minutes before they are required to occupy the starting area.

5.12.12 Execution of manoeuvres

- a) The manoeuvres must be executed during an uninterrupted flight in the order in which they are listed in the rules.
 b) The competitor may make only one attempt at each manoeuvre during the flight.
 c) The pilot has six (6) minutes to start his motor, and five (5) minutes to complete his flight. The six minutes start when the competitor is given permission to start his motor. The last minute of preparation time (ie after the expiry of five minutes) must be announced to the competitor. The five minute flight time starts with either the expiry of the six minute preparation time or when the model aircraft starts the take-off sequence, whichever occurs first.
 d) The model aircraft must take-off and land unassisted, that is, no hand launched flights. If any part of the model aircraft is dropped during the flight, scoring will cease at that point and the competitor must be instructed to land his model aircraft immediately.
 e) The direction of the manoeuvres is determined by the heading of the model aircraft during the take-off. After completion of manoeuvre 13 the model aircraft has to be landed immediately. The flight ends when the landing sequence is completed.
 f) Scoring will cease with the expiry of the five-minute flight period.

cont/...

5.12.13 Schedule of manoeuvres

	K-Factor
Take-off sequence, including single free pass (not judged, not scored)	
01: Triangle loop with full roll on top	3
02: Half reverse Cuban 8 with 2/4-point roll	2
03: Opposite knife-edge	5
04: Immelmann with full roll, exit inverted	2
05: Half reverse Cuban 8 from top with 2/4-point rolls, exit inverted	4
06: Half square loop on corner	2
07: Figure 9 with full roll up	3
08: Pull-push-pull humpty bump with half roll down	3
09: 45 degree ascent with 4/8-point roll, exit inverted	3
10: Half positive loop	1
11: Half slow roll, 2/4-point roll opposite	5
12: Pull-pull-pull humpty bump with half roll down	3
13: Loop with full roll integrated on top 90 degrees	4
Landing (not judged, not scored)	

	Total K 40

For the description of the manoeuvres, judging notes, and Aresti diagrams, see Annex 5X.

For the Manoeuvre Execution Guide, see Annex 5B.

ANNEX 5X**F3S – RADIO CONTROLLED AEROBATIC JET MODEL AIRCRAFT****DESCRIPTION OF MANOEUVRES**

- 5X.1 Triangle loop with full roll on top**
From upright, pull to a 45 degree upline. Pull through $\frac{3}{8}$ of an inside loop to horizontal inverted and perform a full roll. Pull through $\frac{3}{8}$ of an inside loop to a 45 degree downline. Pull to exit upright.
- 5X.2 Half reverse Cuban 8 with 2/4-point roll**
From upright, pull to a 45 degree upline and perform 2 points of a 4-point roll. Pull through $\frac{5}{8}$ of an inside loop to exit upright.
- 5X.3 Opposite knife-edge**
From upright, on a horizontal line, perform a $\frac{1}{4}$ roll to knife-edge. Perform a $\frac{1}{2}$ roll in the opposite direction, to knife-edge, and perform a $\frac{1}{4}$ roll to exit upright.
- 5X.4 Immelmann with full roll, exit inverted**
From upright, pull through a half inside loop, followed immediately by a full roll. Exit upright.
- 5X.5 Reverse cuban 8, 2/4-point rolls, exit inverted**
From inverted, pull to a 45 degree inverted downline, and perform 2 points of an 4-point roll. Pull through a $\frac{3}{4}$ inside loop to a 45 degree inverted downline, perform 2 points of a 4-point roll, and pull through $\frac{5}{8}$ inside loop to exit inverted.
- 5X.6 Half square loop on corner**
From inverted, pull to a 45 degree downline. Pull through 90 degrees to a 45 degree downline and pull through $\frac{1}{8}$ loop to exit upright.
- 5X.7 Figure 9, full roll up**
From upright, pull through $\frac{1}{4}$ loop to a vertical upline, and perform a roll. Pull through a $\frac{3}{4}$ inside loop to exit upright.
- 5X.8 Pull-push-pull humpty bump, half roll down**
From upright, pull through $\frac{1}{4}$ loop to a vertical upline, and push through $\frac{1}{2}$ outside loop. On the vertical downline, perform a half roll, and pull through $\frac{1}{4}$ loop to exit upright. Judging notes: • Exit lower than entry
- 5X.9 45 degree ascent with 4/8-point roll, exit inverted**
From upright, pull to a 45 degree upline and perform 4 points of a 8-point roll. Pull through $\frac{1}{4}$ loop to exit inverted.
- 5X.10 Half positive loop**
From inverted, pull through $\frac{1}{2}$ loop to exit upright.
- 5X.11 Half slow roll, 2/4-point roll opposite**
From upright, perform a slow roll, followed by 2 points of a 4-point roll in the opposite direction, to exit upright.
- 5X.12 Pull-pull-pull humpty bump, half roll down**
From upright, pull through $\frac{1}{4}$ loop to a vertical upline, and pull through $\frac{1}{2}$ inside loop. On the vertical downline, perform a half roll, and pull through $\frac{1}{4}$ loop to exit upright.
- 5X.13 Loop, with full roll integrated over top 90 degrees**
From upright, perform an inside loop with a fully integrated full roll over the top 90 degrees of the loop.

The Aresti diagrams appear overleaf.

F3S Schedule of Manoeuvres (2011)

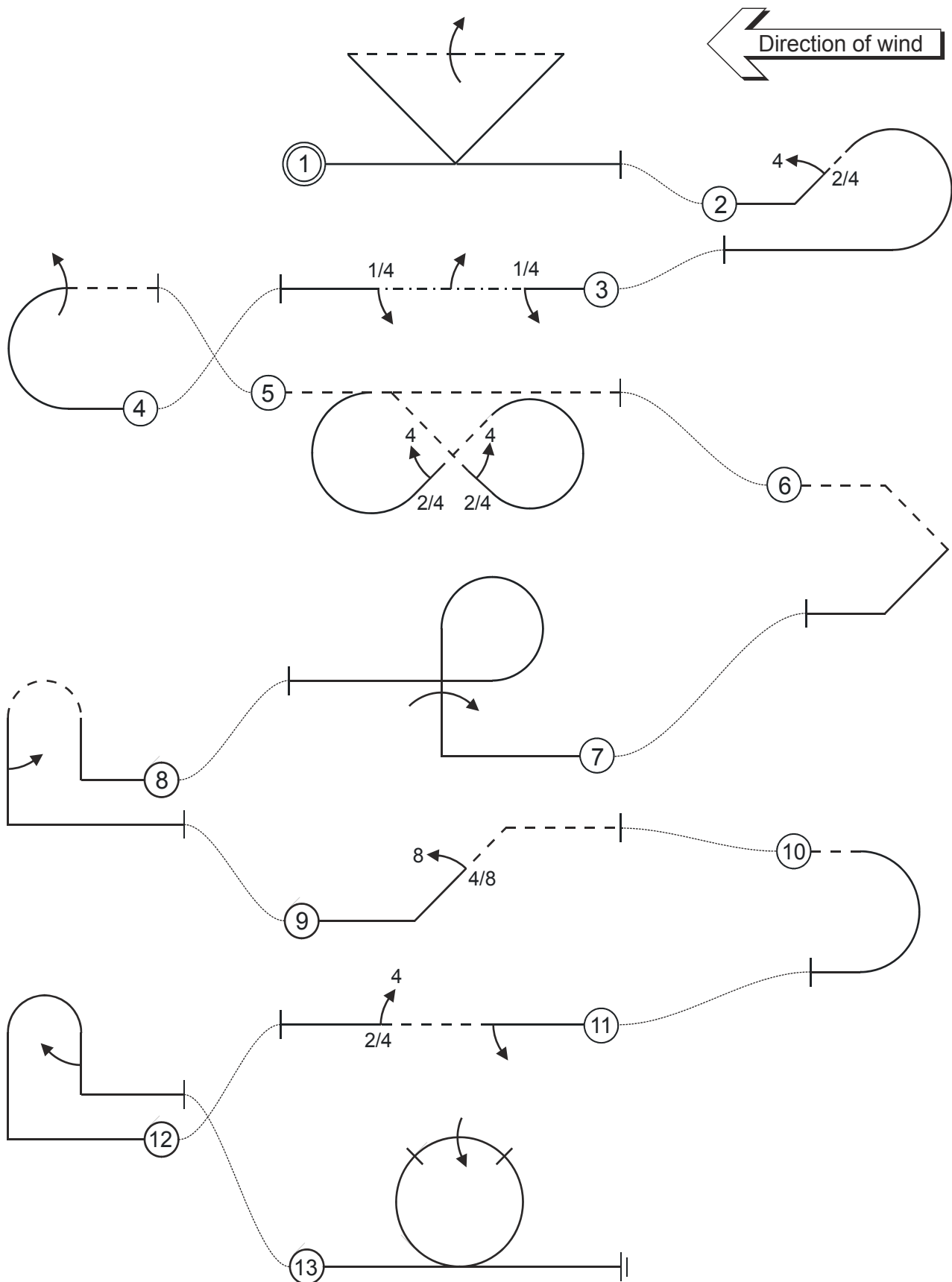

ANNEX 5N

RULES FOR WORLD CUP EVENTS

F3A AEROBATIC WORLD CUP

5N.1. Class

The F3A class is recognised for World Cup competition (aerobatic model aircraft).

5N.2. Competitors

All competitors in the specified open international contests are eligible for the World Cup.

5N.3. Contests

Contests included in the World Cup must appear on the FAI Contest Calendar, and must be run according to the FAI Sporting Code. The contests eligible for a World Cup in a particular year, must be nominated before the CIAM Bureau Meeting at the end of the preceding year, and must be included in the FAI Contest Calendar. The selection of the contests should be according to the following guidelines:

- a) a maximum of two contests may be selected for any one country.
- b) each competitor may count only one competition from each country in Europe (taking the better score for any European country in which he has scored in two competitions).
- c) five (5) judges have to be appointed for each judges' panel and a TBL scoring system has to be applied.

5N.4. Points allocation

The points to be allocated to competitors will depend on the number (N) of competitors who have completed at least one flight in the event. A competitor has completed a flight if he registers a score greater than zero (0).

Points are allocated to competitors who have completed at least one flight in the event, according to their placing in the results, as given in the following tables:

a) $N > 20$

Placing	1	2	3	4	5	6	20	21 and after
Points	20	19	18	17	16	15	1	0

A bonus of 8 points is given to the first placed competitor; 5 points to the second placed and 3 points to the third placed.

b) $N \leq 20$

Placing	1	2	3	4	5	6	N-1	N
Points	N	N-1	N-2	N-3	N-4	N-5	2	1

The bonus is defined as follows:

- for first place: $N/3$ rounded up to the nearest whole number of points, with a maximum of 7 points;
- for second place: $N/5$ rounded up to the nearest whole number of points, with a maximum of 4 points;
- for third place: $N/7$ rounded up to the nearest whole number of points, with a maximum of 3 points.

In the event of a tie between competitors for any placing, the competitors will share the points which would have been awarded to the places covered had the tie been resolved (round up the score to the nearest whole number of points).

cont/...

5N.5. Classification

The World Cup results are determined by considering the total of points obtained by each competitor in the World Cup events. Up to three events may be counted, selecting each competitor's best scores during the year. The winner of the World Cup is the competitor with the greatest total.

In the event of a tie for first, second, and third place, the place will be determined according to the following criteria:

The number of events counted is increased, one at a time, from three until the winner is obtained. If this does not separate the tied competitors, then the winner will be determined by considering the points obtained in the best three events multiplied by the number of competitors who have completed at least one flight in the event. The winner is the one with the greatest total thus calculated.

5N.6. Awards

The winner is awarded the title of winner of the World Cup. Certificates, medals and trophies may be awarded by the CIAM F3 Aerobatics sub-committee if available.

5N.7. Organisation

The F3 Aerobatics sub-committee shall be responsible for organising the World Cup, and may nominate a responsible person or special sub-committee to collate the results.

5N.8. Communication

The F3 Aerobatics sub-committee nominated World Cup coordinator must receive the results from each contest in the World Cup, and then calculate and publish the World Cup positions. These should be distributed to the news agencies and should also be available, by payment of a nominal fee, to any interested bodies or individuals. Final results of the World Cup must be sent to the FAI, National Airports Controls, and the modelling press.

5N.9. Responsibilities of competition organisers

Competition organisers must propose their event for inclusion in the World Cup, when nominating events for the FAI international Sporting Calendar. The final selection of events from these proposals is made by the CIAM Bureau as defined in paragraph 3.

Immediately after the event, the competition organiser must send the results to the World Cup coordinator, within one month as required in the Sporting code B.2.5. Any failure to return scores promptly will be reviewed by the CIAM Bureau when considering the competition calendar for the following year.

5N.10. Board of judges

A board of three responsible people shall be nominated by the CIAM F3 Aerobatics sub-committee to rule on any protest concerning the World Cup during a year. Any protest must be submitted in writing to the F3 Aerobatics sub-committee chairman and must be accompanied by a fee of 35 Euros. In the event of the jury upholding the protest, the fee will be returned.